

CPR915P

Product Family	Drawer
Commercial height	14 cm
Type	Reheat



Aesthetics

Aesthetic	Victoria	Material	Painted material
Colour	Cream	Logo	Silk screen
Finishing	Matt	Logo position	Inside

Controls

Type of control setting	Control knobs	Control knobs	Standard
Type of temperature control	Electro-mechanic	Controls colour	Steel effect
No. of controls	1		

Program / Functions

Defrost	Yes
Proofing	Yes
Mug warmer	Yes
Keep warm	Yes
Dish warmer	Yes
Reheating	Yes

Technical Features

Opening mechanism	Push-pull	Capacity	21 l
Base material	Stainless steel	Type of heating	Fan assisted
Max weight allowance	15 kg	Accessories included	Silicone antislip mat

Maximum drawer loading weight 85 kg

Electrical Connection

Plug	(F;E) Schuko	Voltage (V)	220-240 V
Nominal power	400 W	Frequency (Hz)	50-60 Hz
Current	2 A		

Logistic Information

Width (mm)	597 mm	Product Height (mm)	135 mm
Depth (mm)	538 mm		

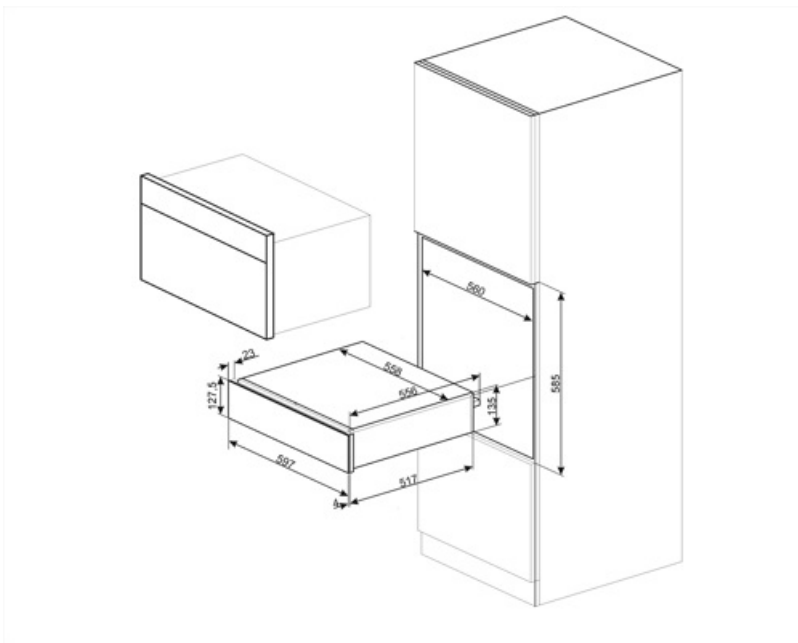

Compatible Accessories

KITCABLE90UK

Cable with IEC connector and UK plug

Alternative products

CPR915X

Colour: Stainless steel



CPR915N

Colour: Black

