

CPV115S

Product Family	Drawer
Commercial height	15 cm
Type	Sous-vide
Vitality system	Yes







Aesthetics

Aesthetic	Linea	Material	Glass
Colour	Silver	Logo	Silk screen
Finishing	Silver	Logo position	Inside









Controls

Type of control setting	Touch control
-------------------------	---------------

Program / Functions

Preservation cycle	
Vacuum in container cycle	
Chef function	
Welding	

Technical Features

							
Opening mechanism	Push-pull	Safety solenoid valve	Yes	anti oil reflux	Yes	Dehumidification pump	Yes, automatic
Base material	Stainless steel 304	Dehumidification pump	Yes, automatic	cycle			
Lid material	Tempered glass with frame						
Lid opening	65° +/- 3°						

Drawer stabilisation device	Yes	Enabling vacuum bar lenght	260 mm
Drawer maximum protrusion	453 +/- 2 mm	Removable enabling vacuum bar	Yes
Max weight allowance	15 kg	Welding type	Double-phase
Maximum drawer loading weight	48 kg	Preservation cycle duration	1' - 1'20"
Capacity	6,5 l	Reachable vacuum	2-10 millibar (99,9%)
Pump flow	4 m ³ /h	Vacuum sensor	Yes, accuracy 10 mbar
		Accessories included	20x30 V-bags, 25x35 V-Bags

Electrical Connection

Plug	(F;E) Schuko	Voltage (V)	220-240 V
Nominal power	240 W	Frequency (Hz)	50-60 Hz
Current	1 A		

Logistic Information

Width (mm)	597 mm	Product Height (mm)	135 mm
Depth (mm)	570 mm		

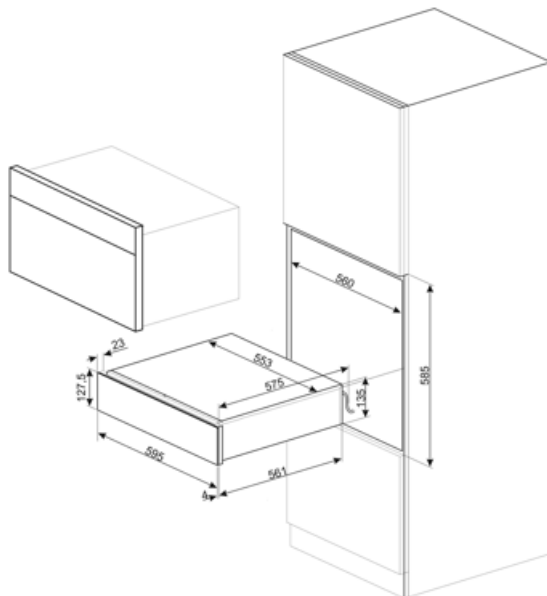

Compatible Accessories



LIFEBOX

Set of 3 containers for vacuum drawer



VBAG1



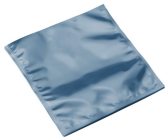







Bags for sous-vide cooking and preservation, 20x30, 50 pieces



VBAG2

Bags for sous-vide cooking and preservation, 25x35, 50 pieces

Symbols glossary

- | | | | |
|--|---|---|--|
|  | The Chef function alternates compression and decompression cycles and speeds up some operations, such as marinade or infusion, that otherwise would require a lot of time. |  | Preservation vacuum bags. These bags endure temperatures from -25°C to 70°C (for 2 hours) or 100°C (for 15 minutes). Suitable for pantry, refrigerator and freezer storage, they cannot be used for vacuum cooking. |
|  | The vacuum in bag function guarantees to create vacuum into bags choosing among three levels. It is also possible to set the 0 level to seal the bag without creating the vacuum. |  | The stabilization device maintains the drawer open when used, avoiding closing it accidentally. |
|  | Sous-vide cooking bags. These bags endure a maximum temperature of 85°C (for 75 hours), 100°C (for 4 hours) or 121°C (for 30 minutes). Suitable for pantry and refrigerator storage, they cannot be storage in the freezer. |  | The vacuum in container function guarantees to create vacuum into glass or plastic containers choosing among three different levels. Use only certificate containers suitable for vacuum and able to resist to a 99,9% vacuum. |
|  | Setting the highest vacuum in bag/container level, it is reached a 99,9% vacuum. |  | The vacuum sensor guarantees the achievement of the maximum vacuum connected to the level set. If the value is not reached, the bag is not sealed. |
|  | The machine can be set at three different sealing levels. Setting the maximum level is possible to seal more bags at the same time with a unique cycle. |  | The machine carries out a double phase welding which guarantees to seal dirty and oily bags as well. |