

# CPV615NR

Product Family	Drawer
Commercial height	15 cm
Type	Sous-vide
Vitality system	Yes







## Aesthetics

Aesthetic	Dolce Stil Novo	Glass type	Eclipse
Colour	Black	Front panel	With horizontal strip
Finishing	Glossy black	Logo	Silk screen
Component finishing	Copper	Logo position	Inside
Material	Glass		







## Controls

Type of control setting	Touch control
-------------------------	---------------

## Programs / Functions

Preservation cycle	
Vacuum in container cycle	
Chef function	
Welding	

## Technical Features

					
Opening mechanism	Push-pull	Safety solenoid valve	anti oil reflux	Yes	
Base material	Stainless steel 304				
Lid material	Tempered glass with frame				

<b>Lid opening</b>	65° +/- 3°	<b>Dehumidification pump cycle</b>	Yes, automatic
<b>Drawer stabilisation device</b>	Yes	<b>Enabling vacuum bar lenght</b>	260 mm
<b>Drawer maximum protrusion</b>	453 +/- 2 mm	<b>Removable enabling vacuum bar</b>	Yes
<b>Max weight allowance</b>	15 kg	<b>Welding type</b>	Double-phase
<b>Maximum drawer loading weight</b>	48 kg	<b>Preservation cycle duration</b>	1' - 1'20"
<b>Capacity</b>	6,5 l	<b>Reachable vacuum</b>	2-10 millibar (99,9%)
<b>Pump flow</b>	4 m <sup>3</sup> /h	<b>Vacuum sensor</b>	Yes, accuracy 10 mbar
		<b>Accessories included</b>	20x30 V-bags, 25x35 V-Bags

## Electrical Connection

<b>Plug</b>	(F;E) Schuko	<b>Voltage (V)</b>	220-240 V
<b>Nominal power</b>	240 W	<b>Frequency (Hz)</b>	50-60 Hz
<b>Current</b>	1 A		

## Logistic Information

<b>Width (mm)</b>	597 mm	<b>Product Height (mm)</b>	135 mm
<b>Depth (mm)</b>	570 mm		

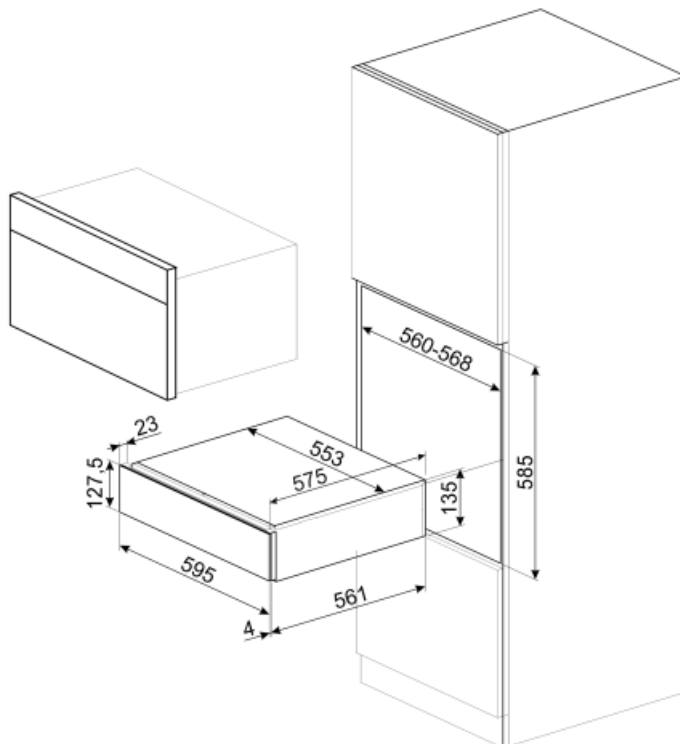

---

## Not included accessories

---



### **V BAG 1**

Bags for sous-vide cooking and preservation, 20x30, 50 pieces

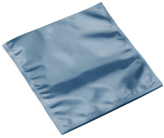

### **V BAG 2**











Bags for sous-vide cooking and preservation, 25x35, 50 pieces



### **LIFEBOX**

Set of 3 containers for vacuum drawer

## Symbols glossary (TT)

- |  |   |   |  |
|--|---|---|--|
|    | The Chef function alternates compression and decompression cycles and speeds up some operations, such as marinade or infusion, that otherwise would require a lot of time.  |    | Preservation vacuum bags. These bags endure temperatures from -25°C to 70°C (for 2 hours) or 100°C (for 15 minutes). Suitable for pantry, refrigerator and freezer storage, they cannot be used for vacuum cooking.            |
|    | The vacuum in bag function guarantees to create vacuum into bags choosing among three levels. It is also possible to set the 0 level to seal the bag without creating the vacuum.   |    | The stabilization device maintains the drawer open when used, avoiding closing it accidentally.  |
|    | Sous-vide cooking bags. These bags endure a maximum temperature of 85°C (for 75 hours), 100°C (for 4 hours) or 121°C (for 30 minutes). Suitable for pantry and refrigerator storage, they cannot be storage in the freezer. |    | The vacuum in container function guarantees to create vacuum into glass or plastic containers choosing among three different levels. Use only certificate containers suitable for vacuum and able to resist to a 99,9% vacuum. |
|    | Setting the highest vacuum in bag/container level, it is reached a 99,9% vacuum.  |    | The vacuum sensor guarantees the achievement of the maximum vacuum connected to the level set. If the value is not reached, the bag is not sealed.   |
|  | The machine can be set at three different sealing levels. Setting the maximum level is possible to seal more bags at the same time with a unique cycle.   |  | The machine carries out a double phase welding which guarantees to seal dirty and oily bags as well.   |