

# CPV615NR

Product Family	Drawer
Commercial height	14 cm
Type	Sous-vide
Vitality system	Yes



## Aesthetics

Aesthetic	Dolce Stil Novo	Glass type	Eclipse
Colour	Black	Front panel	With horizontal strip
Finishing	Glossy black	Logo	Silk screen
Component finishing	Copper	Logo position	Inside
Material	Glass		

## Controls

Type of control setting	Touch control
-------------------------	---------------

## Technical Features



Opening mechanism	Push-pull	Safety solenoid valve anti oil reflux	Yes
Base material	Stainless steel 304	Dehumidification pump cycle	Yes, automatic
Lid material	Tempered glass with frame	Enabling vacuum bar length	260 mm
Lid opening	65° +/- 3°	Removable enabling vacuum bar	Yes
Drawer stabilisation device	Yes	Welding type	Double-phase
Drawer maximum protrusion	453 +/- 2 mm	Preservation cycle duration	1' - 1'20"
Max weight allowance	15 kg	Reachable vacuum	2-10 millibar (99,9%)
Maximum drawer loading weight	48 kg	Vacuum sensor	Yes, accuracy 10 mbar
Capacity	6,5 l		
Pump flow	4 m <sup>3</sup> /h		

**Accessories included** 20x30 V-bags, 25x35 V-Bags

## Electrical Connection

<b>Plug</b>	(F;E) Schuko	<b>Voltage (V)</b>	220-240 V
<b>Nominal power</b>	240 W	<b>Frequency (Hz)</b>	50-60 Hz
<b>Current</b>	1 A		

## Logistic Information

<b>Width (mm)</b>	597 mm	<b>Product Height (mm)</b>	135 mm
<b>Depth (mm)</b>	570 mm		

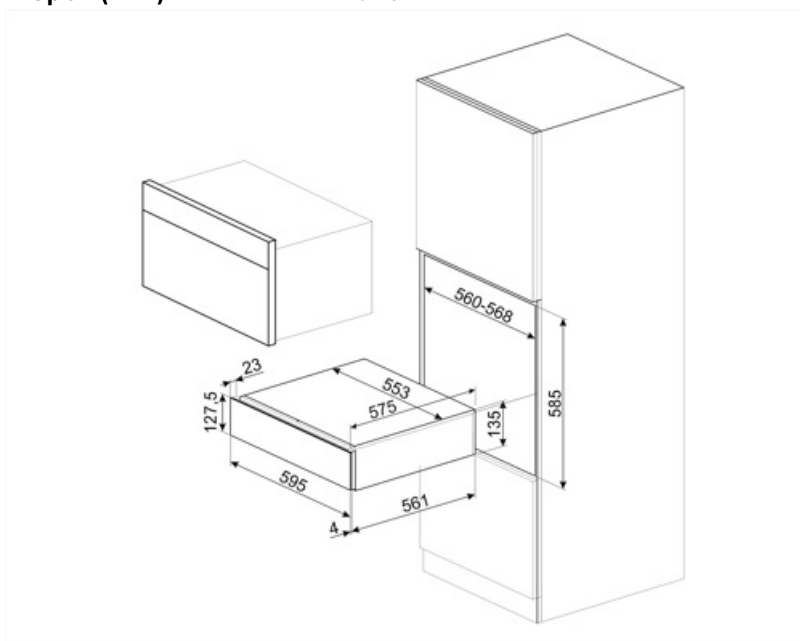

---

## Not included accessories

---



### **V BAG 1**

Bags for sous-vide cooking and preservation, 20x30, 50 pieces

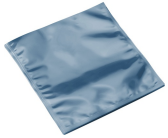

### **V BAG 2**











Bags for sous-vide cooking and preservation, 25x35, 50 pieces



### **LIFEBOX**

Set of 3 containers for vacuum drawer

## Symbols glossary (TT)

- |  |   |   |  |
|--|---|---|--|
|    | The Chef function alternates compression and decompression cycles and speeds up some operations, such as marinade or infusion, that otherwise would require a lot of time.  |    | Preservation vacuum bags. These bags endure temperatures from -25°C to 70°C (for 2 hours) or 100°C (for 15 minutes). Suitable for pantry, refrigerator and freezer storage, they cannot be used for vacuum cooking.            |
|    | The vacuum in bag function guarantees to create vacuum into bags choosing among three levels. It is also possible to set the 0 level to seal the bag without creating the vacuum.   |    | The stabilization device maintains the drawer open when used, avoiding closing it accidentally.  |
|    | Sous-vide cooking bags. These bags endure a maximum temperature of 85°C (for 75 hours), 100°C (for 4 hours) or 121°C (for 30 minutes). Suitable for pantry and refrigerator storage, they cannot be storage in the freezer. |    | The vacuum in container function guarantees to create vacuum into glass or plastic containers choosing among three different levels. Use only certificate containers suitable for vacuum and able to resist to a 99,9% vacuum. |
|    | Setting the highest vacuum in bag/container level, it is reached a 99,9% vacuum.  |    | The vacuum sensor guarantees the achievement of the maximum vacuum connected to the level set. If the value is not reached, the bag is not sealed.   |
|  | The machine can be set at three different sealing levels. Setting the maximum level is possible to seal more bags at the same time with a unique cycle.   |  | The machine carries out a double phase welding which guarantees to seal dirty and oily bags as well.   |

## Benefit (TT)

---

### **Push-pull door opening**

With a simple push, the drawer opens and then closes again by pushing it back.

### **Vitality System**

The combined use of the steam oven, blast chiller and vacuum drawer allows the preservation of product characteristics and maximum flavour enhancement

### **Preservation cycle**

3 preservation cycles (delicate, preservation, sous vide)

### **Vacuum in container cycle**

3 vacuum levels (delicate, medium, strong)

### **Chef function**

Perfect marinades and infusions thanks to Chef mode