

CPV615NR

| | |
|-------------------|-----------|
| Product Family | Drawer |
| Commercial height | 14 cm |
| Type | Sous-vide |
| Vitality system | Yes |







Aesthetics

| | | | |
|---------------------|-----------------|---------------|-----------------------|
| Aesthetic | Dolce Stil Novo | Glass type | Eclipse |
| Colour | Black | Front panel | With horizontal strip |
| Finishing | Glossy black | Logo | Silk screen |
| Component finishing | Copper | Logo position | Inside |
| Material | Glass | | |







Controls

| | |
|-------------------------|---------------|
| Type of control setting | Touch control |
|-------------------------|---------------|

Program / Functions

| | |
|---------------------------|---|
| Preservation cycle |  |
| Vacuum in container cycle |  |
| Chef function |  |
| Welding |  |

Technical Features

| | | | | | | |
|--|---|---|---|---|---|--|
|  |  |  |  |  |  | |
| Opening mechanism | Push-pull | Safety solenoid valve | anti oil reflux | Yes | | |
| Base material | Stainless steel 304 | | | | | |
| Lid material | Tempered glass with frame | | | | | |

| | | | |
|--------------------------------------|---------------------|--------------------------------------|----------------------------|
| Lid opening | 65° +/- 3° | Dehumidification pump cycle | Yes, automatic |
| Drawer stabilisation device | Yes | Enabling vacuum bar lenght | 260 mm |
| Drawer maximum protrusion | 453 +/- 2 mm | Removable enabling vacuum bar | Yes |
| Max weight allowance | 15 kg | Welding type | Double-phase |
| Maximum drawer loading weight | 48 kg | Preservation cycle duration | 1' - 1'20" |
| Capacity | 6,5 l | Reachable vacuum | 2-10 millibar (99,9%) |
| Pump flow | 4 m ³ /h | Vacuum sensor | Yes, accuracy 10 mbar |
| | | Accessories included | 20x30 V-bags, 25x35 V-Bags |

Electrical Connection

| | | | |
|----------------------|--------------|-----------------------|-----------|
| Plug | (F;E) Schuko | Voltage (V) | 220-240 V |
| Nominal power | 240 W | Frequency (Hz) | 50-60 Hz |
| Current | 1 A | | |

Logistic Information

| | | | |
|-------------------|--------|----------------------------|--------|
| Width (mm) | 597 mm | Product Height (mm) | 135 mm |
| Depth (mm) | 570 mm | | |

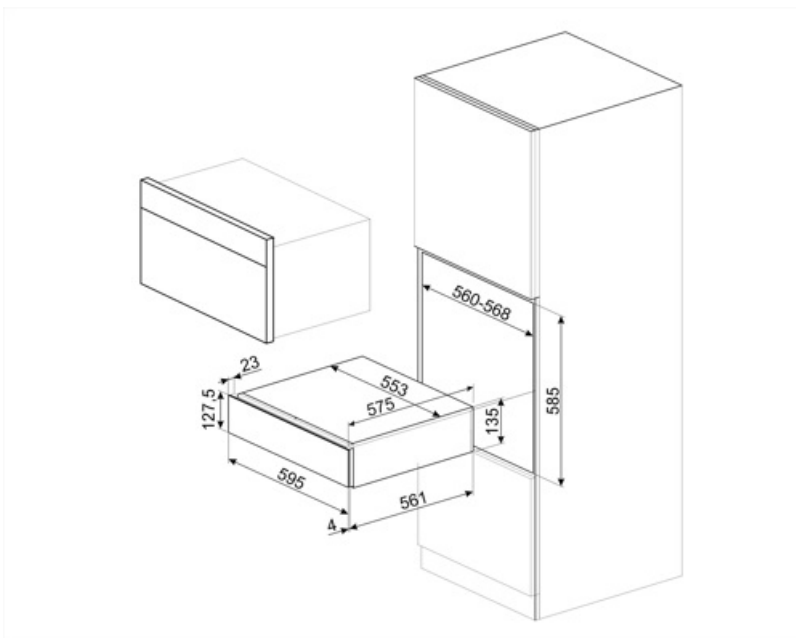

Compatible Accessories



LIFEBOX

Set of 3 containers for vacuum drawer



VBAG1



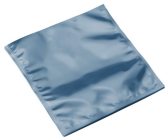







Bags for sous-vide cooking and preservation, 20x30, 50 pieces



VBAG2

Bags for sous-vide cooking and preservation, 25x35, 50 pieces

Symbols glossary

- | | | | |
|--|---|---|--|
|  | The Chef function alternates compression and decompression cycles and speeds up some operations, such as marinade or infusion, that otherwise would require a lot of time. |  | Preservation vacuum bags. These bags endure temperatures from -25°C to 70°C (for 2 hours) or 100°C (for 15 minutes). Suitable for pantry, refrigerator and freezer storage, they cannot be used for vacuum cooking. |
|  | The vacuum in bag function guarantees to create vacuum into bags choosing among three levels. It is also possible to set the 0 level to seal the bag without creating the vacuum. |  | The stabilization device maintains the drawer open when used, avoiding closing it accidentally. |
|  | Sous-vide cooking bags. These bags endure a maximum temperature of 85°C (for 75 hours), 100°C (for 4 hours) or 121°C (for 30 minutes). Suitable for pantry and refrigerator storage, they cannot be storage in the freezer. |  | The vacuum in container function guarantees to create vacuum into glass or plastic containers choosing among three different levels. Use only certificate containers suitable for vacuum and able to resist to a 99,9% vacuum. |
|  | Setting the highest vacuum in bag/container level, it is reached a 99,9% vacuum. |  | The vacuum sensor guarantees the achievement of the maximum vacuum connected to the level set. If the value is not reached, the bag is not sealed. |
|  | The machine can be set at three different sealing levels. Setting the maximum level is possible to seal more bags at the same time with a unique cycle. |  | The machine carries out a double phase welding which guarantees to seal dirty and oily bags as well. |