

CR329X

Product Family Drawer
 Commercial height 29 cm
 Type Reheat



Aesthetics

| | | | |
|------------------|-----------------|----------------------|----------|
| Aesthetic | Classica | Type of steel | Brushed |
| Colour | Stainless steel | Handle | Classic |
| Finishing | Fingerproof | Logo | Embossed |
| Material | Stainless steel | Logo position | External |

Controls

| | | | |
|------------------------------------|------------------|------------------------|--------------|
| Type of control setting | Control knobs | Control knobs | Standard |
| Type of temperature control | Electro-mechanic | Controls colour | Steel effect |
| No. of controls | 1 | | |

Program / Functions

| | |
|--------------------|-----|
| Defrost | Yes |
| Proofing | Yes |
| Mug warmer | Yes |
| Keep warm | Yes |
| Dish warmer | Yes |
| Reheating | Yes |

Technical Features

| | | | |
|-----------------------------|-----------------|------------------------|--------------|
| Opening mechanism | With handle | Capacity | 51 l |
| Base material | Stainless steel | Type of heating | Fan assisted |
| Max weight allowance | 15 kg | | |

| | | | |
|-------------------------------|-------|----------------------|-----------------------|
| Maximum drawer loading weight | 85 kg | Accessories included | Silicone antislip mat |
|-------------------------------|-------|----------------------|-----------------------|

Electrical Connection

| | | | |
|---------------|--------------|----------------|-----------|
| Plug | (F;E) Schuko | Voltage (V) | 220-240 V |
| Nominal power | 400 W | Frequency (Hz) | 50-60 Hz |
| Current | 2 A | | |

Logistic Information

| | | | |
|------------|--------|---------------------|--------|
| Width (mm) | 597 mm | Product Height (mm) | 290 mm |
| Depth (mm) | 538 mm | | |

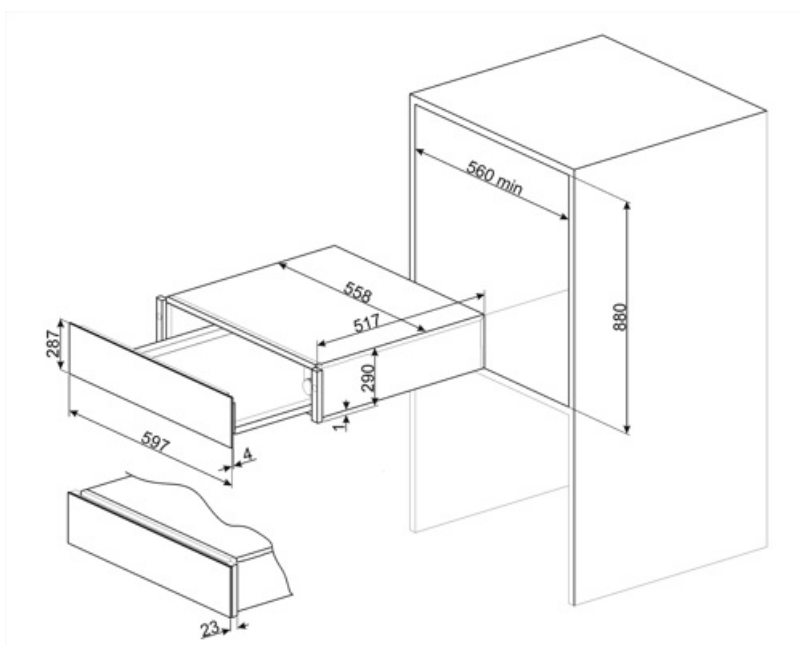

Symbols glossary



Fingerprint proof stainless steel: Fingerprint proof stainless steel keeps stainless steel looking as good as new.