

# CS9GMXA

Cooker size	90x60 cm
N. of cavities with energy label	1
Cavity heat source	ELECTRICITY
Hob type	Gas
Type of main oven	Thermoseal
Cleaning system main oven	Vapour Clean
EAN code	8017709224639



## Aesthetics



<b>Design</b>	Square design	<b>Control knobs</b>	Smeg Classic
<b>Command panel finish</b>	Finger friendly stainless steel	<b>Controls colour</b>	Stainless steel
<b>Aesthetic</b>	Classic	<b>No. of controls</b>	8
<b>Logo</b>	Assembled st/steel	<b>Serigraphy colour</b>	Black
<b>Colour</b>	Stainless steel	<b>Display</b>	Touch
<b>Logo position</b>	Facia below the oven	<b>Door</b>	With 2 horizontal strips
<b>Finishing</b>	Satin	<b>Glass type</b>	eclipse
<b>Upstand</b>	Yes	<b>Handle</b>	Smeg Classic
<b>Serie</b>	Sinfonia	<b>Handle Colour</b>	Brushed stainless steel
<b>Hob colour</b>	Stainless steel	<b>Storage compartment</b>	Door
<b>Type of pan stands</b>	Cast Iron	<b>Feet</b>	Silver
<b>Type of control setting</b>	Control knobs	<b>Plinth</b>	Stainless steel

## Programs / Functions

No. of cooking functions 8

Traditional cooking functions



Static



Fan assisted



Circulaire



Eco



Large grill



Fan grill (large)



Fan assisted bottom

## Cleaning functions

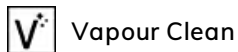

## Hob technical features



**Total no. of cook zones** 6

Front left - Gas - UR - 4.40 kW

Rear left - Gas - AUX - 1.05 kW

Front centre - Gas - AUX - 1.05 kW

Rear centre - Gas - Semi Rapid - 2.10 kW

Rear right - Gas - Rapid - 3.30 kW

Front right - Gas - Semi Rapid - 2.10 kW

**Type of gas burners** Standard

**Gas safety valves** Yes

**Automatic electronic ignition** Yes

**Burner caps** Matte black enamelled

## Main Oven Technical Features



**No. of lights** 2

**Fan number** 2

**Net volume of the cavity** 115 l

**Gross volume, 1st cavity** 126 l

**Cavity material** Ever Clean enamel

**No. of shelves** 5

**Type of shelves** Metal racks

**Light type** Halogen

**Light Power** 40 W

**Cooking time setting** Start and Stop

**Light when oven door is open** Yes

**Door opening** Flap down

**Removable door** Yes

**Full glass inner door** Yes

**Removable inner door** Yes

**Total no. of door glasses** 3

**No. of thermo-reflective door glasses** 2

**Safety Thermostat** Yes

**Cooling system** Tangential

**Usable cavity space dimensions (HxWxD)** 371x724x418 mm

**Temperature control** Electro-mechanical

**Lower heating element power** 1700 W

**Upper heating element - Power** 1200 W

**Grill element** 1700 W

**Large grill - Power** 2900 W

**Circular heating element - Power** 2 x 1550 W

**Grill type** Electric

## Options Main Oven

**Timer** Yes

**End of cooking acoustic alarm** Yes

**Minimum Temperature** 50 °C

**Maximum temperature** 260 °C

## Accessories included for Main Oven & Hob



Cast iron wok support	1	40mm deep tray	1
Rack with back and side stop	1	Grill mesh	1
20mm deep tray	1	Telescopic Guide rails, total Extraction	1

## Electrical Connection

Electrical connection rating	3200 W	Power supply cable length	120 cm
Current	14 A	Frequency	50/60 Hz
Voltage	220-240 V	Terminal block	3 poles
Type of electric cable installed	Yes, Single phase	Plug	(I) Australia

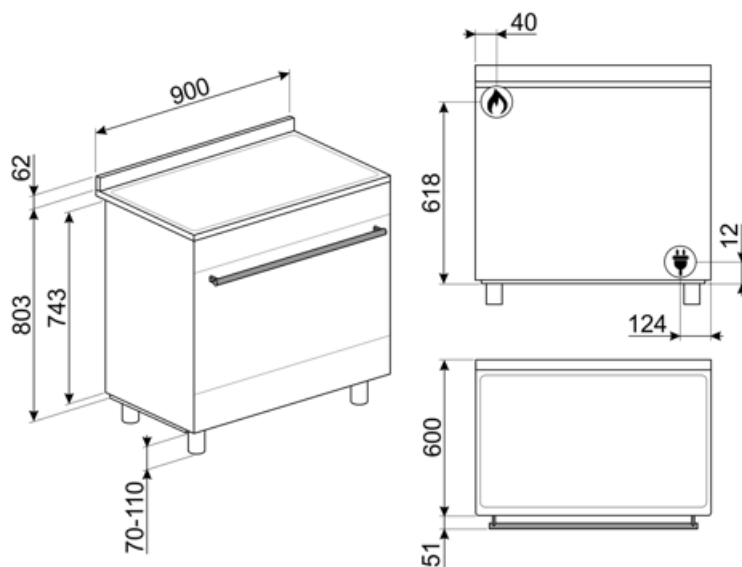

## Compatible Accessories

### AIRFRY

Air fryer rack AIRFRY. Ideal for recreating traditional frying in the oven, but with fewer calories and less fat. It allows you to cook quickly and simply dishes such as French fries, fried vegetables and fish, ensuring perfect browning and crispiness.



### AIRFRY9

Air fryer rack AIRFRY . Ideal for recreating traditional frying in the oven, but with fewer calories and less fat. It allows you to cook quickly and simply dishes such as French fries, fried vegetables and fish, ensuring perfect browning and crispiness.



### BBQ9

teflon-coated aluminum grid for 90 cm cavity



### BN940

Enamelled tray 90 cm, 40 mm deep



### GTT

\*\*Totally extractable telescopic guides (1 level)\*\* Extraction: 433 mm Material: Stainless steel AISI 430 polished



### KITPBX

Height reduction feet (850 mm)



### SFLK1

Child lock



### AIRFRY2

Air fryer tray. Ideal for recreating traditional frying in the oven, but with fewer calories and less fat. It allows you to cook quickly and simply dishes such as French fries, fried vegetables and fish, ensuring perfect browning and crispiness.



### BBQ

Double sided plate BBQ. Suitable for recreating succulent and crispy dishes in the oven with the typical taste of grilled cooking. The ribbed side is particularly suitable for meats and cheeses. The smooth side for fish, seafood and vegetables.



### BN920

Enamelled tray 90cm cavity, 20mm deep



### GTP

\*\*Partially extractable telescopic guides (1 level)\*\* Extraction: 300 mm Material: Stainless steel AISI 430 polished



### KITC9X9-1

Splashback, 90x75 cm, stainless steel, suitable for Portofino, Master and Sinfonia cookers

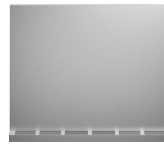

### PALPZ

Pizza shovel with fold away handle width: 315mm length : 325mm







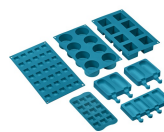



















### SMOLD

Set of 7 silicone moulds for ice creams, ice lollies, pralines, ice cubes or to portion food. Usable from -60°C to +230°C



## Symbols glossary

 <p>Heavy duty cast iron pan stands: for maximum stability and strength.</p>	 <p>Installation in column: Installation in column</p>
 <p>Air cooling system: to ensure a safe surface temperatures.</p>	 <p>Triple glazed doors: Number of glazed doors.</p>
 <p>Enamel interior: The enamel interior of all Smeg ovens have a special antacid lining which helps keep the interior clean by reducing the amount of cooking grease adhering to it.</p>	 <p>Fingerprint proof stainless steel: Fingerprint proof stainless steel keeps stainless steel looking as good as new.</p>
 <p>Fan assisted base: the mix of fan and lower heating element alone allows to finish cooking foods already cooked on the surface but not internally more quickly. This system is recommended to finish cooking foods that are already well cooked on the surface, but not internally, which therefore require a moderate higher heat. Ideal for any type of food.</p>	 <p>Fan with upper and lower elements: The elements combined with the fan aim to provide more uniform heat, a similar method to conventional cooking, so pre-heat is required. Most suitable for items requiring slow cooking methods.</p>
 <p>Upper and lower element only: a traditional cooking method best suited for single items located in the centre of the oven. the top pf the oven will always be hottest. Ideal for roast, fruit cakes, bread etc.</p>	 <p>Circulaire: The combination of the fan and circular element around it gives a hot air cooking method. This provides many benefits including no preheat if cook time is more than 20 minutes, no flavour transfer when cooking different foods at the same time, less energy, and shorter cook times. Good for all types of food.</p>
 <p>ECO: The combination of the grill, fan and lower element is particularly suitable for cooking small quantities of food.</p>	 <p>Grill element: Using of grill gives excellent results when cooking meat of medium and small portions, especially when combined with a rotisserie (where possible). Also ideal for cooking sausages and bacon.</p>
 <p>Fan with grill element: The fan reduces the fierce heat from the grill, providing an excellent method of grilling various foods, chops, steaks, sausages etc. giving even browning and heat distribution, without drying out the food. The top two levels recommended for use, and the lower part of the oven can be used to keep items warm at the same time, an excellent facility when cooking a grilled breakfast. Half grill (centre portion only) is ideal for small quantities of food.</p>	 <p>All glass inner door: All glass inner door, a single flat surface which is simple to keep clean.</p>
 <p>The inner door glass: can be removed with a few quick movements for cleaning.</p>	 <p>Side lights: Two opposing side lights increase visibility inside the oven.</p>
 <p>Automatic opening: some models have Automatic opening door when the cycle is finished which is a perfect solution for handle-less kitchen units as no handle is needed. For safety reasons, the door locks automatically when the machine is in use to avoid it being opened inadvertently.</p>	 <p>The oven cavity has 5 different cooking levels.</p>

- 
- |  |   |   |   |
|--|---|---|---|
|  | Telescopic rails: allow you to pull out the dish and check it without having to remove it from the oven entirely. |  | Ultra rapid burners: Powerful ultra rapid burners offer up to 5kw of power.     |
|  | Vapour Clean: a simple cleaning function using steam to loosen deposits in the oven cavity.                       |  | The capacity indicates the amount of usable space in the oven cavity in litres. |
|  | 4.3 inch display with LED technology, usability with knobs + 3 touch keys   |  | Knobs control   |