

CVI121B3

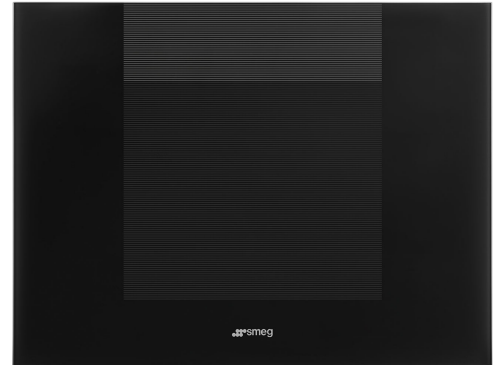

Family	Wine Cooler
Installation	Built-in
Built-In Niche	45 cm
Defrost	Automatic
Cooling type	Fan assisted
Hinge type	Variable hinge
Hinge position	Right
Reversible door	Yes



Wine cellar compartment features



Number of fixed shelves	1
Number of removable shelves	2
No. of lights	1
Shelves material	Wood
Removable shelves on telescopic guide rails	Yes
Type of internal light	Led
Air filter	Activated charcoal filter

Programs/Functions



Control setting	Touch control	Control lock	Yes
Controls	Inner, in the cellar compartment	Lighting forced ON	In a maximum period
Display	LED	Fan forced ON	Yes
Functions display	Temperature alarm, Temperature value	Temperature Alarm	Yes
Power on lamp	Yes	Door open alarm	Yes

Technical Features

Adjustable temperature zones	1	Number of compressors	1
		Compressor type	Low vibration compressor
		Refrigerant gas type	R600a

Independent cooling systems	1	Refrigerant Quantity (gr)	20 g
Number of door glasses	2	Foam agent	HFO
Temperature range	5-20 °C	Metal panel on the back of the fridge	Metal
Type of temperature control	Electronic	Door opening type	With push pull system
Anti-UV door glass	Yes		
Integrated heating element	Yes		

Performance / Energy Label - Reg. 2019







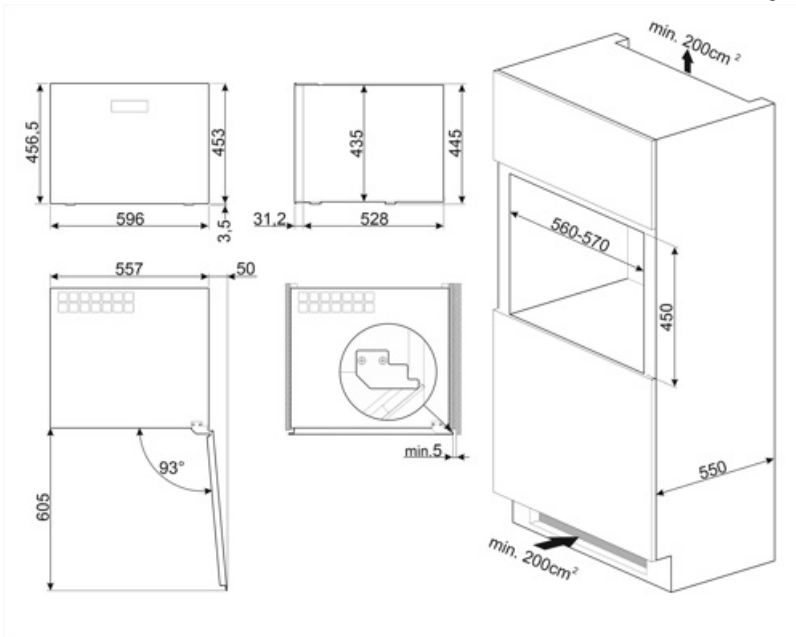

Max Capacity (bottles 0,75lt)	21	Sum of the volumes of the chill compartment(s) and the unfrozen compartment(s)	56 l
Annual energy consumption	100 kWh/a	Climate class	SN, N, ST
Energy efficiency class	F	EEl	124 %
Airborne acoustical noise emission class	C	Noise level	36 dB(A) re 1 pW
Total net volume	56 l		

Electrical Connection

Plug	(F;E) Schuko	Voltage (V)	220-240 V
Electrical connection rating	40 W	Frequency (Hz)	50 Hz
Current	0,4 A	Power supply cable length	180 cm



Symbols glossary

	The automatic defrost system works by automatically defrosting at regular intervals eliminating the need to defrost altogether.		A+: Energy efficiency class A+ helps to save up to 10% energy compared to class A. Maximum performance with minimum consumption is guaranteed.
	LED display: to show programmes, functions and options selected and the time to the end of the cycle.		Ventilated: Forced distribution of cold air in the refrigerator compartment, which allows even temperature distribution within the fridge.
	LED interior lighting: is a more energy efficient and long lasting way of illuminating the interior of the appliance.		Built-in niche
	Touch controls: Easy to use touch controls allow the appliance to be programmed at the touch of a button.		Energy efficiency class F

Benefit (TT)

Reversible door

Reversible door for easy and versatile installation in any kitchen

Push-pull opening system

Push-pull opening system for easy opening and closing when needed, with the simple pressure of the surface at the end of the door

UV-protected door glass

The UV-protected door glass protects the bottles from the passage of light into the wine cooler for impeccable storage

LED lights

LED lights ensure perfect multi-level visibility inside the wine cooler

Activated charcoal air filter

The activated charcoal air filter ensures excellent quality of the air and is easy to maintain

Touch Display

Touch display for an easy and accurate temperature management inside the refrigerated compartment

Low-vibration compressor

The low-vibration compressor avoids exposing the bottles to prolonged vibrations, which could compromise the quality of the wine

Telescopic guides

Telescopic sliding guides for easy extraction of wine bottles