

CVI121G



Familie	Wijnklimaatkast
Installatie	Inbouw
Niche	45 cm
Ontdooien	Automatisch
Type koelen	Geventileerd
Type scharnier	Omkeerbare deur
Positie scharnier	Rechts
Deur omkeerbaar	Ja



Eigenschappen compartimenten



Aantal vaste legplanken	1
Aantal uitneembare legplanken	2
Aantal lampen	1
Materiaal legplanken	Hout
Uitneembare legplanken op telescopische rails	Ja
Type interne verlichting	LED
Luchtfilter	Koolstoffilter

Programma's/Functies



Bediening	Touch bediening	Kinderbeveiliging	Ja
Type bediening	Binnenkant	Geforceerde verlichting AAN	Maximum periode
Display	LCD	Geforceerde ventilatie AAN	Ja
Display functies	Temperatuuralarm, Temperatuurwaarde	Temperature Alarm	Ja
Vermogen lamp	Ja	Alarm open deur	Ja

Technische specificaties

Aanpasbare temperatuurzones	1	Aantal compressoren	1
Onafhankelijke koelsystemen	1	Type compressor	Compressor lage vibraties
		Type koelgas	R600a
		Hoeveelheid koelmiddel	20 g

Aantal glazen in de deur	2	Schuimmiddel	HFO
Temperatuur	5-20 °C	Metalen paneel op achterzijde koelkast	Plaatstaal
Type temperatuurcontrole	Elektronisch	Opening deur	Met push pull systeem
Anti-UV glazen deur	Ja		
Geïntegreerd warmte-element	Ja		

Prestaties/Energie label - Reg. 2019







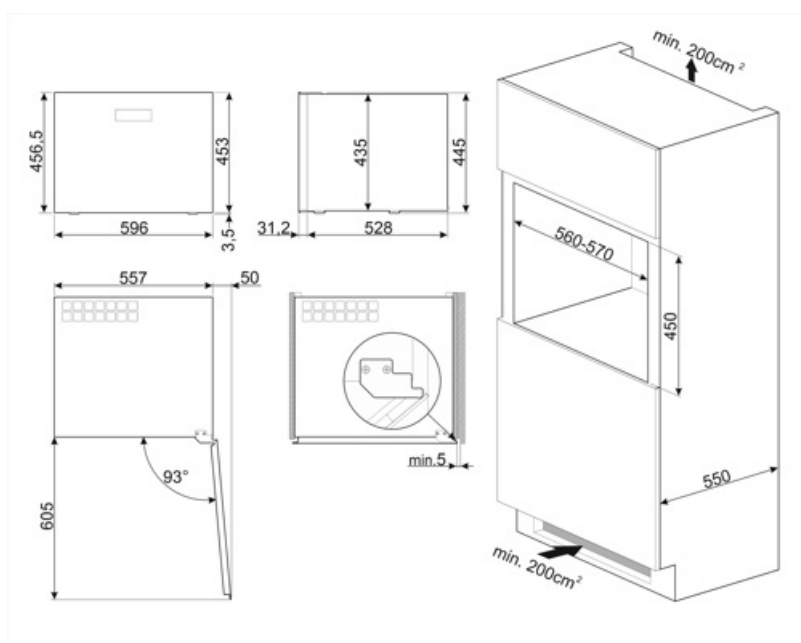

			
Maximum capaciteit (flessen 0,75l)	21	Netto inhoud koelgedeeltes	56 l
Annual energy consumption	100 kWh/jaar	Klimaatklasse	SN, N, ST
Energie-efficiëntieklasse	F	EEl	124 %
Emissieklasse voor akoestisch luchtgeluid	C	Geluidsniveau	36 dB(A) re 1 pW
Totaal netto volume	56 l		

Elektrische aansluiting

Nominale aansluitwaarde	40 W	Frequentie (Hz)	50 Hz
Stroom (A)	0,4 A	Lengte voedingskabel	180 cm
Spanning (V)	220-240 V	Stekker	(F;E) Schuko



Symbols glossary

	The automatic defrost system works by automatically defrosting at regular intervals eliminating the need to defrost altogether.		A+: Energy efficiency class A+ helps to save up to 10% energy compared to class A. Maximum performance with minimum consumption is guaranteed.
	LCD display: to optimize performance and simplify the use of the appliance.		Geventileerd: een geforceerde verdeling van koude lucht in het koelkast compartiment, die een gelijke temperatuurverdeling verzekert in de koelkast.
	LED interior lighting: is a more energy efficient and long lasting way of illuminating the interior of the appliance.		Built-in niche
	Bediening met touch knoppen: dankzij de gebruiksvriendelijke aanraakbediening kan het apparaat met één druk op de knop worden geprogrammeerd.		Energie-efficiëntieklasse