

CVI129G



Family	Wine Cooler
Installation	Built-in
Built-In Niche	60 cm
Defrost	Automatic
Cooling type	Fan assisted
Hinge type	Variable hinge
Reversible door	Yes



Wine cellar compartment features



Number of fixed shelves	1
Number of removable shelves	2
No. of lights	2
Shelves material	Wood
Removable shelves on telescopic guide rails	Yes
Type of internal light	Led
Air filter	Activated charcoal filter

Programs/Functions



Control setting	Touch control	Control lock	Yes
Controls	Inner, in the cellar compartment	Lighting forced ON	In a maximum period
Display	LCD	Fan forced ON	Yes
Functions display	Temperature alarm, Temperature value	Temperature Alarm	Yes
Power on lamp	Yes	Door open alarm	Yes

Technical Features

Adjustable temperature zones	2	Number of compressors	1
		Compressor type	Low vibration compressor
		Refrigerant gas type	R600a

Independent cooling systems	1	Refrigerant Quantity (gr)	20 g
Number of door glasses	2	Foam agent	HFO
Temperature range	5-20 °C	Metal panel on the back of the fridge	Metal
Type of temperature control	Electronic	Door opening type	With push pull system
Anti-UV door glass	Yes		
Integrated heating element	Yes		

Performance / Energy Label - Reg. 2019





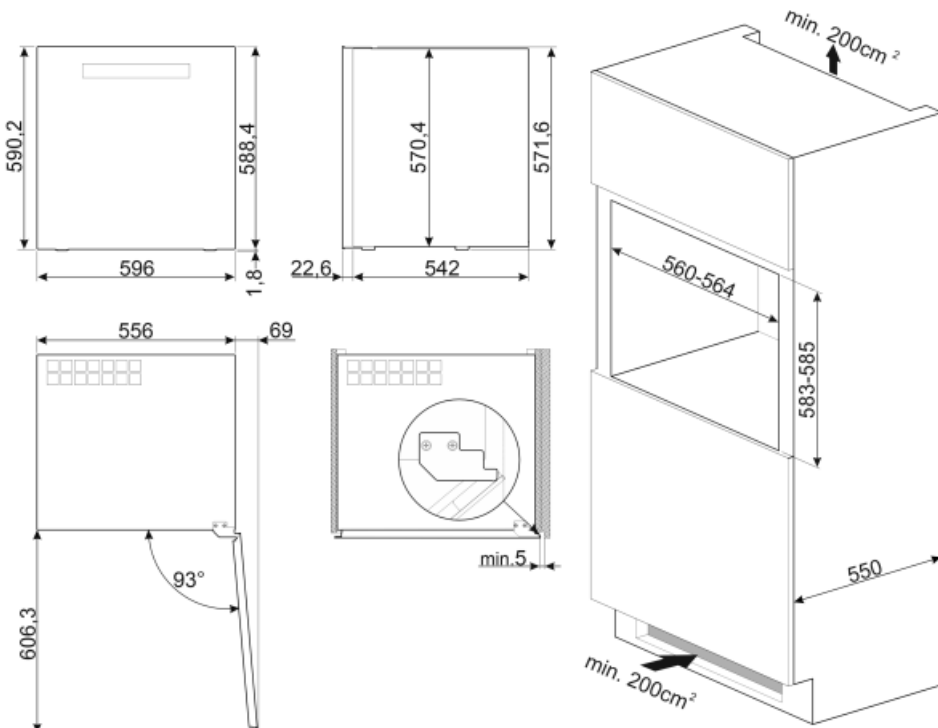

Max Capacity (bottles 0,75lt)	29	Sum of the volumes of the chill compartment(s) and the unfrozen compartment(s)	79 l
Annual energy consumption	140 kWh/a	Climate class	SN, N, ST
Energy efficiency class	G	EEl	170 %
Airborne acoustical noise emission class	C	Noise level	38 dB(A) re 1 pW
Total net volume	79 l		

Electrical Connection

Plug	(F;E) Schuko	Voltage (V)	220-240 V
Electrical connection rating	40 W	Frequency (Hz)	50 Hz
Current	0,4 A	Power supply cable length	180 cm



Symbols glossary (TT)

- | | | | |
|--|--|---|---|
|  | The automatic defrost system works by automatically defrosting at regular intervals eliminating the need to defrost altogether. |  | |
|  | Energy efficiency class G |  | LCD display: to optimize performance and simplify the use of the appliance. |
|  | Ventilated: Forced distribution of cold air in the refrigerator compartment, which allows even temperature distribution within the fridge. |  | LED interior lighting: is a more energy efficient and long lasting way of illuminating the interior of the appliance. |
|  | Touch controls: Easy to use touch controls allow the appliance to be programmed at the touch of a button. | | |