

CVI138LS3



Product Family	Wine Cooler
Installation	Built-in
Built-In Niche	82-87 cm
Defrost	Automatic
Cooling type	Fan assisted
Hinge type	Standard
Hinge position	Left



Wine cooler compartment features



Number of fixed shelves	2
Number of removable shelves	3
Shelves material	Wood
Removable shelves on telescopic guide rails	Yes
Type of internal light	LED
Air filter	Activated charcoal filter

Programs / Functions



Control setting	Touch control	Control lock	Yes
Controls	Internal, in the compartment	Lighting forced ON	In a maximum period
Display	LED	Fan forced ON	Yes
Functions display	Temperature alarm, Temperature value	Temperature Alarm	Yes
Power on lamp	Yes	Door open alarm	Yes

Technical Features

Adjustable temperature zones	2	Compressor type	Low vibration compressor
Independent cooling systems	2	Refrigerant gas type	R600a
Number of door glasses	2	Refrigerant Quantity (gr)	20 g

Temperature range	5-20 °C	Foam agent	HFO
Type of temperature control	Electronic	Metal panel on the back of the fridge	Metal
Anti-UV door glass	Yes	Adjustable feet	2 Front + 2 Rear
Integrated heating element	Yes	Door opening type	With handle
Number of compressors	1		

Performance / Energy Label NEW







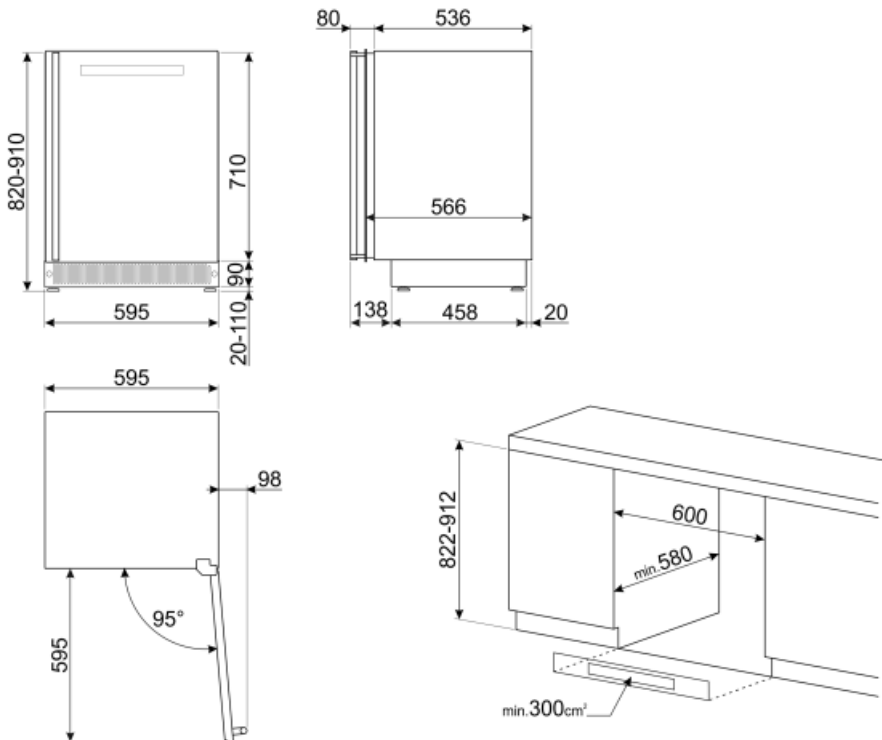

Max Capacity (bottles 0,75lt)	38	Sum of the volumes of the chill compartment(s) and the unfrozen compartment(s)	114 l
Annual energy consumption	140 kWh/year	Climatic class	SN, N, ST
Energy efficiency class	G	EEL	165 %
Airborne acoustical noise emission class	C	Noise level	38 dB(A) re 1 pW
Total volume	114 l		

Electrical Connection

Plug	(F;E) Schuko	Voltage (V)	220-240 V
Nominal power	40 W	Frequency (Hz)	50 Hz
Current	0,4 A	Power supply cable length	150 cm



Symbols glossary

	The automatic defrost system works by automatically defrosting at regular intervals eliminating the need to defrost altogether.		Energy efficiency class G		A: Product drying performance, measured from A+++ to D / G depending on the product family
	Ventilated: Forced distribution of cold air in the refrigerator compartment, which allows even temperature distribution within the fridge.		LED display: to show programmes, functions and options selected and the time to the end of the cycle.		LED interior lighting: is a more energy efficient and long lasting way of illuminating the interior of the appliance.
	Built-in niche		Touch controls: Easy to use touch controls allow the appliance to be programmed at the touch of a button.		