

CVI138RS3

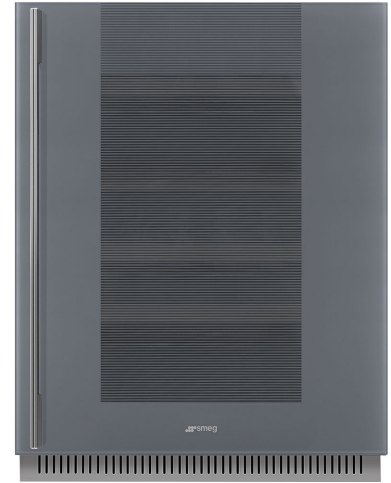

Family	Adega
Installation	Built-in
Built-In Niche	82-87 cm
Defrost	Automatic
Cooling type	Fan assisted
Hinge type	Standard
Hinge position	Right
Reversible door	No



Wine cellar compartment features



Number of fixed shelves	2
Number of removable shelves	3
Shelves material	Wood
Adjustable shelves	No
Removable shelves on telescopic guide rails	Yes
Type of internal light	Led
Air filter	Activated charcoal filter

Programs/Functions



Control setting	Touch control	Lighting forced ON	In a maximum period
Controls	Inner, in the cellar compartment	Fan forced ON	Yes
Display	LED	Temperature Alarm	Yes
Functions display	Temperature alarm, Temperature value	Door open alarm	Yes
Power on lamp	Yes	Humidity level setting	No
Control lock	Yes		

Technical Features

Adjustable temperature zones	2	Number of compressors	1
		Compressor type	Low vibration compressor
		Refrigerant gas type	R600a

Independent cooling systems	2	Refrigerant Quantity (gr)	20 g
Number of door glasses	2	Espuma expansiva de isolamento	HFO
Temperature range	5-20 °C	Painel de metal na parte de trás da geladeira	Metal
Type of temperature control	Electronic	Adjustable feet	2 Front + 2 Rear
Anti-UV door glass	Yes	Door opening type	With handle
Integrated heating element	Yes		
Antibacterial Gasket	No		

Etiqueta de Desempenho / Energia - Reg. 2019







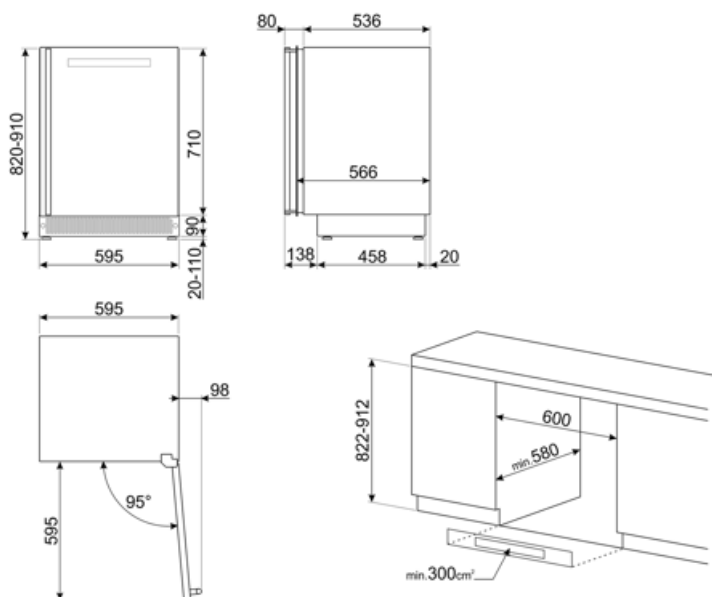

			
Consumo de energia anual	140 kWh/a	Soma dos volumes do(s) compartimento(s) refrigerado(s) e do(s) compartimento(s) não congelado(s)	114 l
Classe de eficiência energética	G	Classe climática	SN, N, ST
Classe de emissão de ruído acústico aerotransportado	C	EEl	165 %
Volume líquido total	114 l	Noise level	38 dB(A) re 1 pW

Electrical Connection

Plug	(F;E) Schuko	Voltage (V)	220-240 V
Electrical connection rating	40 W	Frequency (Hz)	50 Hz
Current	0,4 A	Comprimento do cabo de alimentação	150 cm



Symbols glossary

	O sistema de descongelamento automático funciona descongelando automaticamente em intervalos regulares, eliminando a necessidade de descongelar completamente.		R: Desempenho de secagem do produto, medido de A++ a D/G, dependendo da família de produtos
	Classe de eficiência energética G		Display LED: para mostrar os programas, funções e opções selecionadas e o tempo até ao final do ciclo.
	Ventilado: Distribuição forçada de ar frio no compartimento da geladeira, o que permite uma distribuição uniforme da temperatura dentro da geladeira.		Iluminação interior LED: é uma forma mais eficiente em termos energéticos e duradoura de iluminar o interior do aparelho.
	Nicho incorporado		Controles táteis: O controles táteis, fáceis de usar, permitem que o aparelho seja programado com o toque de um botão.

Benefit (TT)

External handle

Handle with sober and elegant aesthetics, for easy door opening

UV-protected door glass

The UV-protected door glass protects the bottles from the passage of light into the wine cooler for impeccable storage

LED lights

LED lights ensure perfect multi-level visibility inside the wine cooler

Activated charcoal air filter

The activated charcoal air filter ensures excellent quality of the air and is easy to maintain

Touch Display

Touch display for an easy and accurate temperature management inside the refrigerated compartment

Low-vibration compressor

The low-vibration compressor avoids exposing the bottles to prolonged vibrations, which could compromise the quality of the wine

Telescopic guides

Telescopic sliding guides for easy extraction of wine bottles