

CVI338RX3



Familie	Wijnklimaatkast
Installatie	Inbouw
Niche	82-87 cm
Ontdooien	Automatisch
Type koelen	Geventileerd
Type scharnier	Standaard
Positie scharnier	Rechts



Eigenschappen compartimenten



Aantal vaste legplanken	2
Aantal uitneembare legplanken	3
Materiaal legplanken	Hout
Uitneembare legplanken op telescopische rails	Ja
Type interne verlichting	LED
LuchtfILTER	Koolstoffilter

Programma's/Functies



Bediening	Touch bediening	Kinderbeveiliging	Ja
Type bediening	Binnenkant	Geforceerde verlichting AAN	Maximum periode
Display	LCD	Geforceerde ventilatie AAN	Ja
Display functies	Temperatuuralarm, Temperatuurwaarde	Temperature Alarm	Ja
Vermogen lamp	Ja	Alarm open deur	Ja

Technische specificaties

Aanpasbare temperatuurzones	2	Type compressor	Compressor lage vibraties
Onafhankelijke koelsystemen	2	Type koelgas	R600a
Aantal glazen in de deur	2	Hoeveelheid koelmiddel	20 g
		Schuimmiddel	HFO

Temperatuur	5-20 °C	Metalen paneel op achterzijde koelkast	Plaatstaal
Type temperatuurcontrole	Elektronisch	Aanpasbare voetjes	2 vooraan, 2 achteraan
Anti-UV glazen deur	Ja	Opening deur	Met handvat
Geïntegreerd warmte-element	Ja		
Aantal compressoren	1		

Prestaties/Energie label - Reg. 2019







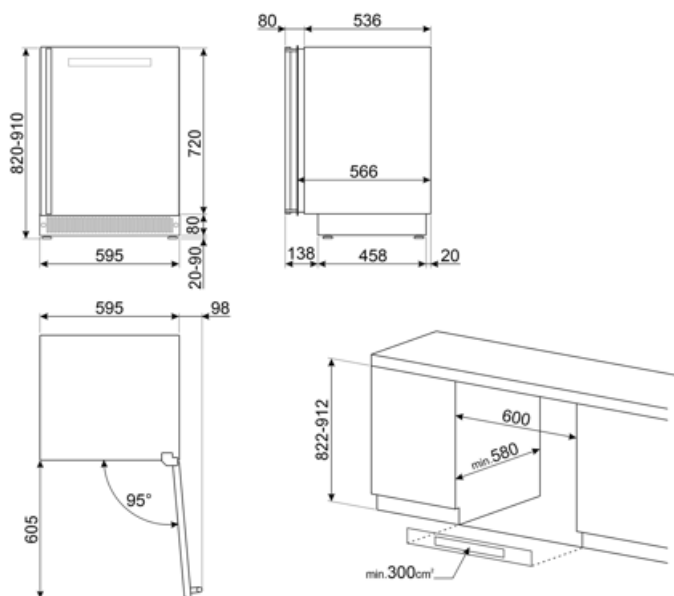

 Maximum capaciteit (flessen 0,75l)	38	Netto inhoud koelgedeeltes	114 l
Annual energy consumption	140 kWh/jaar	Klimaatklasse EEI	SN, N, ST
Energie-efficiëntieklasse	G	Geluidsniveau	38 dB(A) re 1 pW
Emissieklasse voor akoestisch luchtgeluid	C		
Totaal netto volume	114 l		

Elektrische aansluiting

Nominale aansluitwaarde	40 W	Frequentie (Hz)	50 Hz
Stroom (A)	0,4 A	Lengte voedingskabel	180 cm
Spanning (V)	220-240 V	Stekker	(F;E) Schuko



Symbols glossary

	Energy efficiency class A		The automatic defrost system works by automatically defrosting at regular intervals eliminating the need to defrost altogether.
	LED display: to show programmes, functions and options selected and the time to the end of the cycle.		Geventileerd: een geforceerde verdeling van koude lucht in het koelkast compartiment, die een gelijke temperatuurverdeling verzekert in de koelkast.
	Fingerprint proof stainless steel: Fingerprint proof stainless steel keeps stainless steel looking as good as new.		LED interior lighting: is a more energy efficient and long lasting way of illuminating the interior of the appliance.
	Built-in niche		Bediening met touch knoppen: dankzij de gebruiksvriendelijke aanraakbediening kan het apparaat met één druk op de knop worden geprogrammeerd.
	Energie-efficiëntieklasse		