

CVI621RWNX3



Family	Adega
Installation	Built-in
Built-In Niche	45 cm
Defrost	Automatic
Cooling type	Fan assisted
Hinge type	Standard
Hinge position	Right
Reversible door	No



Wine cellar compartment features



Number of fixed shelves	1
Number of removable shelves	2
Shelves material	Wood
Adjustable shelves	No
Removable shelves on telescopic guide rails	Yes
Type of internal light	Led
Air filter	Activated charcoal filter

Programs/Functions



Control setting	Touch control	Lighting forced ON	In a maximum period
Controls	External, in the door	Fan forced ON	Yes
Display	LED	Temperature Alarm	Yes
Functions display	Temperature alarm, Temperature value	Door open alarm	Yes
Power on lamp	Yes	Humidity level setting	No
Control lock	Yes		

Technical Features

Adjustable temperature zones	1	Compressor type	Low vibration compressor
		Refrigerant gas type	R600a
		Refrigerant Quantity (gr)	20 g

Independent cooling systems	1	Espuma expansiva de isolamento	Ciclopentano
Number of door glasses	2	Painel de metal na parte de trás da geladeira	Metal
Temperature range	5-20 °C	Adjustable feet	No
Type of temperature control	Electronic	Door opening type	With push pull system
Anti-UV door glass	Yes		
Integrated heating element	Yes		
Number of compressors	1		

Etiqueta de Desempenho / Energia - Reg. 2019







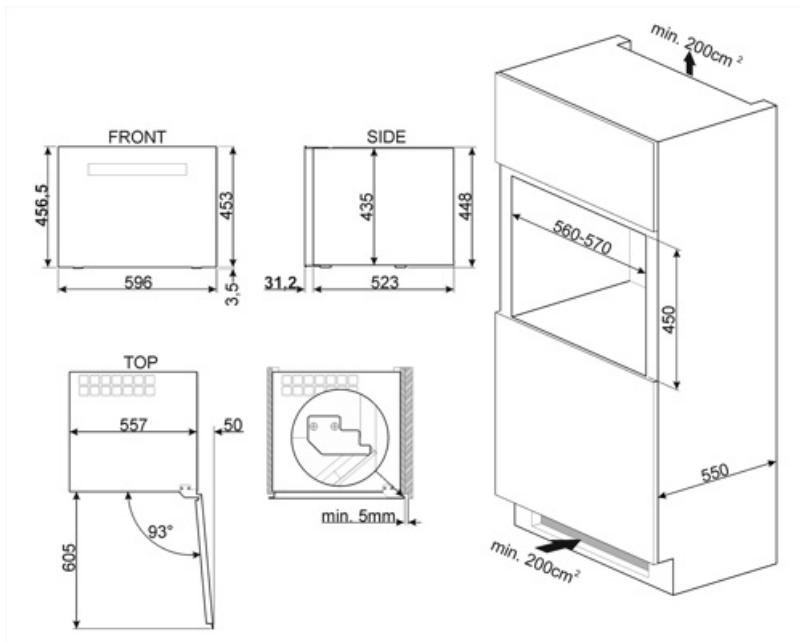



			
Consumo de energia anual	100 kWh/a	Soma dos volumes do(s) compartimento(s) refrigerado(s) e do(s) compartimento(s) não congelado(s)	56 l
Classe de eficiência energética	F	Classe climática	SN, N, ST
Classe de emissão de ruído acústico aerotransportado	C	EEl	124 %
Volume líquido total	56 l	Noise level	36 dB(A) re 1 pW

Electrical Connection

Plug	(F;E) Schuko	Voltage (V)	220-240 V
Electrical connection rating	40 W	Frequency (Hz)	50 Hz
Current	0,4 A	Comprimento do cabo de alimentação	150 cm



Symbols glossary

-  A+: A classe de eficiência energética A+ ajuda a economizar até 10% de energia em comparação com a classe A. O desempenho máximo com consumo mínimo é garantido.
-  Display LED: para mostrar os programas, funções e opções selecionadas e o tempo até ao final do ciclo.
-  Iluminação interior LED: é uma forma mais eficiente em termos energéticos e duradoura de iluminar o interior do aparelho.
-  Aparelhos com conectividade Wi-Fi. Através da aplicação SmegConnect é possível monitorizar e controlar remotamente aparelhos através de smartphone e tablet (iOS e Android).
-  Conectividade Wi-Fi
-  O sistema de descongelamento automático funciona descongelando automaticamente em intervalos regulares, eliminando a necessidade de descongelar completamente.
-  Ventilado: Distribuição forçada de ar frio no compartimento da geladeira, o que permite uma distribuição uniforme da temperatura dentro da geladeira.
-  Nicho incorporado
-  Controles táteis: O controles táteis, fáceis de usar, permitem que o aparelho seja programado com o toque de um botão.
-  Classe de eficiência energética F

Benefit (TT)

Push-pull opening system

Push-pull opening system for easy opening and closing when needed, with the simple pressure of the surface at the end of the door

UV-protected door glass

The UV-protected door glass protects the bottles from the passage of light into the wine cooler for impeccable storage

LED lights

LED lights ensure perfect multi-level visibility inside the wine cooler

Activated charcoal air filter

The activated charcoal air filter ensures excellent quality of the air and is easy to maintain

Touch Display

Touch display for an easy and accurate temperature management inside the refrigerated compartment

Low-vibration compressor

The low-vibration compressor avoids exposing the bottles to prolonged vibrations, which could compromise the quality of the wine

Telescopic guides

Telescopic sliding guides for easy extraction of wine bottles