

## CVI638RWN3



Familie	Wijnklimaatkast
Installatie	Inbouw
Niche	82-87 cm
Ontdooien	Automatisch
Type koelen	Geventileerd
Type scharnier	Standaard
Positie scharnier	Rechts



## Eigenschappen compartimenten



Aantal vaste legplanken	2
Aantal uitneembare legplanken	3
Materiaal legplanken	Hout
Uitneembare legplanken op telescopische rails	Ja
Type interne verlichting	LED
Luchtfilter	Koolstoffilter

## Programma's/Functies



Bediening	Touch bediening	Kinderbeveiliging	Ja
Type bediening	Buitenkant in de deur	Geforceerde verlichting AAN	Maximum periode
Display	LCD	Geforceerde ventilatie AAN	Ja
Display functies	Temperatuuralarm, Temperatuurwaarde	Temperature Alarm	Ja
Vermogen lamp	Ja	Alarm open deur	Ja

## Technische specificaties

Aanpasbare temperatuurzones	2	Type compressor	Compressor lage vibraties
Onafhankelijke koelsystemen	2	Type koelgas	R600a
Aantal glazen in de deur	2	Hoeveelheid koelmiddel	20 g
		Schuimmiddel	Cyclopentaan

Temperatuur	5-20 °C	Metalen paneel op achterzijde koelkast	Plaatstaal
Type temperatuurcontrole	Elektronisch	Aanpasbare voetjes	2 vooraan, 2 achteraan
Anti-UV glazen deur	Ja	Opening deur	Met handvat
Geïntegreerd warmte-element	Ja		
Aantal compressoren	1		

## Prestaties/Energie label - Reg. 2019







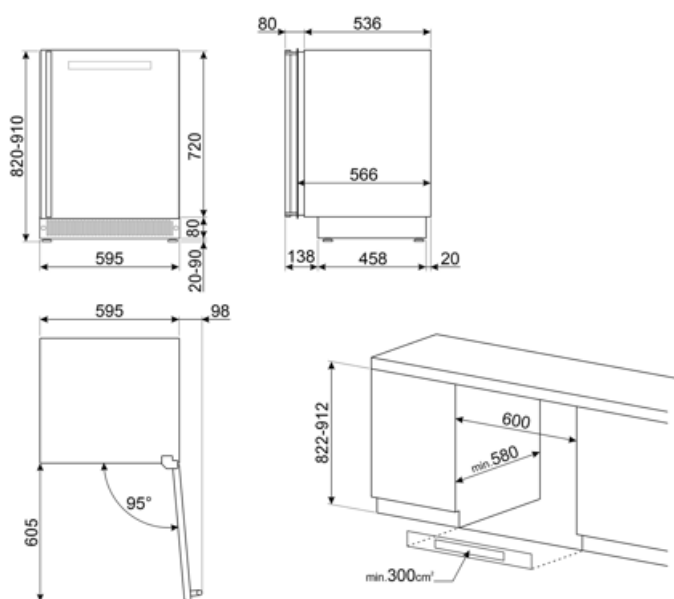

 <b>Maximum capaciteit (flessen 0,75l)</b>	38	<b>Netto inhoud koelgedeeltes</b>	114 l
<b>Annual energy consumption</b>	140 kWh/jaar	<b>Klimaatklasse EEI</b>	SN, N, ST
<b>Energie-efficiëntieklasse</b>	G	<b>Geluidsniveau</b>	38 dB(A) re 1 pW
<b>Emissieklasse voor akoestisch luchtgeluid</b>	C		
<b>Totaal netto volume</b>	114 l		

## Elektrische aansluiting

<b>Nominale aansluitwaarde</b>	40 W	<b>Frequentie (Hz)</b>	50 Hz
<b>Stroom (A)</b>	0.4 A	<b>Lengte voedingskabel</b>	150 cm
<b>Spanning (V)</b>	220-240 V	<b>Stekker</b>	(F;E) Schuko



## Symbols glossary

	The automatic defrost system works by automatically defrosting at regular intervals eliminating the need to defrost altogether.		Energy efficiency class A
	Energie-efficiëntieklasse		LED display: to show programmes, functions and options selected and the time to the end of the cycle.
	Geventileerd: een geforceerde verdeling van koude lucht in het koelkast compartiment, die een gelijke temperatuurverdeling verzekert in de koelkast.		LED interior lighting: is a more energy efficient and long lasting way of illuminating the interior of the appliance.
	Built-in niche		Appliances with Wi-Fi connectivity. Via SmegConnect App is possible to monitor and remotely control appliances through smartphone and tablet (iOS and Android).
	Bediening met touch knoppen: dankzij de gebruiksvriendelijke aanraakbediening kan het apparaat met één druk op de knop worden geprogrammeerd.	