

# CX113GMBL

Cooker size	110x60 cm
N. of cavities with energy label	2
Cavity heat source	ELECTRICITY
Hob type	Gas
Type of main oven	Thermo-ventilated
Type of second oven	Thermo-ventilated
Cleaning system main oven	Ever Clean enamel
EAN code	8017709348212
Energy efficiency class	A
Energy efficiency class, second cavity	A



## Aesthetics



<b>Design</b>	Standard	<b>Type of control knobs</b>	Smeg Classic
<b>Command panel finish</b>	Enamelled metal	<b>Controls colour</b>	Stainless steel
<b>Aesthetic</b>	Classica	<b>No. of controls</b>	8
<b>Logo</b>	Assembled	<b>Serigraphy colour</b>	Silver
<b>Colour</b>	Black	<b>Display name</b>	DigiScreen
<b>Logo position</b>	Command panel	<b>Door</b>	With frame
<b>Finishing</b>	Glossy black	<b>Glass type</b>	Black
<b>Series</b>	Concerto	<b>Handle</b>	Smeg Classic
<b>Hob colour</b>	Black enamel	<b>Handle Colour</b>	Brushed stainless steel
<b>Type of pan stands</b>	Cast Iron	<b>Feet color</b>	none
<b>Type of control setting hob</b>	Control knobs	<b>Plinth</b>	Black

## Programs / Functions main oven

<b>No. of cooking functions</b>	4
<b>Traditional cooking functions</b>	

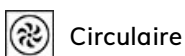

Circulaire



Small grill



Large grill



Fan grill (large)

## Programs / Functions auxiliary oven

Cooking functions cavity 2

1

## Programs / Functions third oven

No. of functions third oven

1

Full grill



## Hob technical features

<b>UR</b>			
<b>Total no. of cook zones 6</b>			
Left - Gas - 2UR (dual) - 4.20 kW			
Rear left - Gas - Rapid - 3.00 kW			
Front left - Gas - AUX - 1.00 kW			
Rear right - Gas - Semi Rapid - 1.80 kW			
Front right - Gas - Semi Rapid - 1.80 kW			
Right - Gas - Rapid - 3.00 kW			
<b>Type of gas burners</b>	Standard	<b>Gas safety valves</b>	Yes
<b>Automatic electronic ignition</b>	Yes	<b>Burner caps</b>	Matt black enamelled

## Main Oven Technical Features



<b>No. of lights</b>	1	<b>Removable door</b>	Yes
<b>Fan number</b>	1	<b>Full glass inner door</b>	Yes
<b>Net volume of the cavity</b>	61 l	<b>Removable inner door</b>	Yes
<b>Gross volume, 1st cavity</b>	70 l	<b>Total no. of door glasses</b>	3
<b>Cavity material</b>	Ever Clean enamel	<b>No. of thermo-reflective door glasses</b>	1
<b>No. of shelves</b>	4	<b>Safety Thermostat</b>	Yes
<b>Type of shelves</b>	Metal racks	<b>Cooling system</b>	Tangential
<b>Light type</b>	Halogen	<b>Usable cavity space dimensions (HxWxD)</b>	316x460x412 mm
<b>Light Power</b>	40 W	<b>Temperature control</b>	Electro-mechanical
<b>Cooking time setting</b>	Start and Stop	<b>Circular heating element - Power</b>	2000 W
<b>Door opening</b>	Side opening		

## Options Main Oven

<b>Timer</b>	Yes	<b>Minimum Temperature</b>	50 °C
<b>End of cooking acoustic alarm</b>	Yes	<b>Maximum temperature</b>	245 °C

## Second Oven Technical Features



<b>Fan number</b>	1	<b>Removable door</b>	Yes
<b>Net volume of the second cavity</b>	61 l	<b>Full glass inner door</b>	Yes
<b>Gross volume, 2nd cavity</b>	70 l	<b>No. total door glasses</b>	2
<b>Cavity material</b>	Ever Clean enamel	<b>No. thermo-reflective door glasses</b>	1
<b>No. of shelves</b>	4	<b>Safety Thermostat</b>	Yes
<b>Type of shelves</b>	Metal racks	<b>Cooling system</b>	Tangential
<b>No. of lights</b>	1	<b>Usable cavity space dimensions (HxWxD)</b>	605x275x370 mm
<b>Light type</b>	Halogen	<b>Temperature control</b>	Electro-mechanical
<b>Light Power</b>	40 W	<b>Circular heating element - Power</b>	2500 W
<b>Door opening</b>	Side opening		

## Options Auxiliary Oven

<b>Minimum Temperature</b>	50 °C	<b>Maximum temperature</b>	245 °C
----------------------------	-------	----------------------------	--------

## Third Oven Technical Features



<b>Net volume, 3rd cavity</b>	35 l	<b>Removable inner door</b>	Yes
<b>Gross volume, 3rd cavity</b>	41 l	<b>No. total door glasses</b>	3
<b>Cavity material</b>	Ever Clean enamel	<b>No. of thermo-reflective door glasses</b>	1
<b>No. of shelves</b>	2	<b>Safety Thermostat</b>	Yes
<b>Type of shelves</b>	Metal racks	<b>Cooling system</b>	Tangential
<b>No. of lights</b>	1	<b>Usable cavity space dimensions (HxWxD)</b>	169x440x443 mm
<b>Light type</b>	Halogen	<b>Temperature control</b>	Electro-mechanical
<b>Light Power</b>	40 W	<b>Large grill - Power</b>	2700 W
<b>Door opening</b>	Flap down	<b>Grill type</b>	Electric
<b>Removable door</b>	Yes	<b>Tilting grill</b>	Yes
<b>Full glass inner door</b>	Yes		

## Options Third Oven

<b>Minimum Temperature</b>	50 °C	<b>Maximum temperature</b>	260 °C
----------------------------	-------	----------------------------	--------

## Accessories included for Main Oven & Hob

<b>Rack with back and side stop</b>	1	<b>40mm deep tray</b>	1
<b>20mm deep tray</b>	1	<b>Grill mesh</b>	1

## Accessories included for Secondary Oven

<b>Grill mesh</b>	1
-------------------	---

Rack with back and side stop 1  
 40mm deep tray 1

## Electrical Connection

Electrical connection rating	8400 W	Additional connection modalities	Double and Three Phase
Current	37 A	Frequency	50/60 Hz
Voltage	220-240 V	Terminal block	5 poles
Voltage 2 (V)	380-415 V	Plug	Not present
Electric cable	Installed, Single phase		

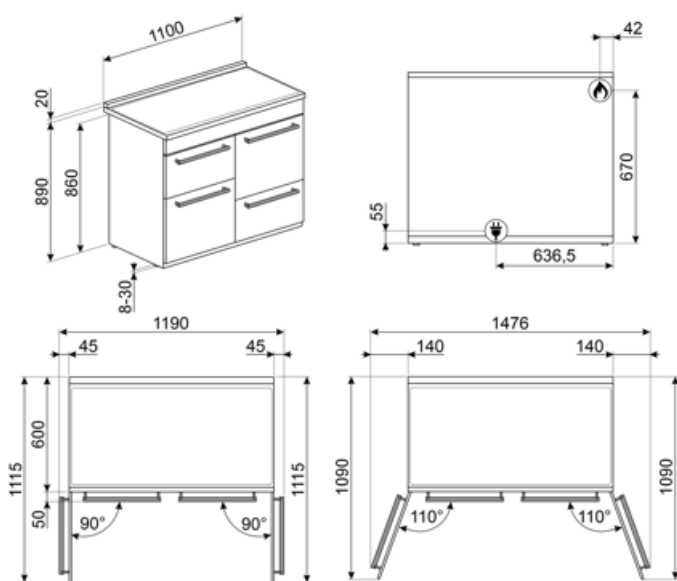

## Compatible Accessories

### AIRFRY

Air fryer rack AIRFRY. Ideal for recreating traditional frying in the oven, but with fewer calories and less fat. It allows you to cook quickly and simply dishes such as French fries, fried vegetables and fish, ensuring perfect browning and crispiness.



### BBQ

Double sided plate BBQ. Suitable for recreating succulent and crispy dishes in the oven with the typical taste of grilled cooking. The ribbed side is particularly suitable for meats and cheeses. The smooth side for fish, seafood and vegetables.



### BN640

Enamelled tray suitable for 45cm and 60cm ovens. Depth 540 mm. Perfect for cooking and roasting meat and fish in sauces. Also ideal for experimenting with lighter and crunchy side dishes



### AIRFRY2

Air fryer tray. Ideal for recreating traditional frying in the oven, but with fewer calories and less fat. It allows you to cook quickly and simply dishes such as French fries, fried vegetables and fish, ensuring perfect browning and crispiness.



### BN620-1

Enamelled tray suitable for 45 cm and 60 cm ovens. Depth 20 mm. Perfect for a wide range of savoury and sweet baking.



### BNP608T

Teflon-coated tray, 8 mm depth, to be placed on the grid



### GRM

Coffee machine support



### GTT

Totally extractable telescopic guides (1 level), suitable for traditional ovens. Made in stainless steel, they guarantee stability and facilitate the smooth extraction of the trays.



### PALPZ

Pizza shovel with folding handle. Dimensions L31.5 x H32.5 cm. Easy and convenient to use and store. Perfect for serving pizza, bread and savory pastries in a safe and professional way.



### GTP

Partially extractable telescopic guides (1 level), suitable for traditional ovens. Made in stainless steel, they guarantee stability and facilitate the smooth extraction of the trays.



### KITH93

Height extension kit (950mm), black, suitable for TR93 cookers (945-960mm)



### SFLK1

Child lock



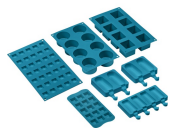

### SMOLD























Set of 7 silicone moulds for ice creams, ice lollies, pralines, ice cubes or to portion food. Usable from -60°C to +230°C



### WOKGHU

Cast iron WOK Support

## Symbols glossary

 Energy efficiency class A	 Heavy duty cast iron pan stands: for maximum stability and strength.
 Installation in column: Installation in column.	 Air cooling system: to ensure a safe surface temperatures.
 Double glazed doors: Number of glazed doors.	 Triple glazed doors: Number of glazed doors.
 Ever Clean Enamel: Ever Clean enamel is applied electrostatically, corner to corner and edge to edge to prevent cracking or cracks over time. It is a particular pyrolytic enamel, resistant to acids which, in addition to being pleasantly bright, promotes greater cleaning of the oven walls, thanks to its lower porosity. It is baked at over 850 °C and slowly polymerized at a scientifically determined rate to ensure uniform depth and strength. Ever Clean enamel creates an impeccable finish both on the inside of the oven and on the trays, making the surfaces of the oven incredibly easy to maintain over time as it reduces the adhesion of fat during cooking.	 Fan assisted: Intense and homogeneous traditional cooking, also suitable for complex recipes. The fan is active and the heat comes from below and from above at the same time. Ventilated cooking ensures a faster and more homogeneous result, leaving fragrant foods outside and moister inside. Ideal for baked pasta, biscuits, roasts and cobblers.
 Circulaire: it is the perfect function for cooking all types of dishes in a more delicate way. The heat comes from the back of the oven and is distributed quickly and evenly. The fan is active. It is also ideal for cooking on multiple levels without mixing smells and flavors.	 Grill: Very intense heat coming only from above from a double heating element. The fan is not active. Provides excellent grilling and gratinating results. Used at the end of cooking, it gives a uniform browning to dishes.
 Grill element: Using of grill gives excellent results when cooking meat of medium and small portions, especially when combined with a rotisserie (where possible). Also ideal for cooking sausages and bacon.	 Half grill: For rapid cooking and browning of foods. Best results can be obtained by using the top shelf for small items, the lower shelves for larger ones, such as chops or sausages. For half grill heat is generated only at the centre of the element, so is ideal for smaller quantities.
 Fan grill: very intense heat coming only from above from a double heating element. The fan is active. It allows the optimal grilling of thickest meats. Ideal for large cuts of meat.	 All glass inner door: All glass inner door, a single flat surface which is simple to keep clean.
 The inner door glass: can be removed with a few quick movements for cleaning.	 Side lights: Two opposing side lights increase visibility inside the oven.
 The oven cavity has 2 different cooking levels.	 The oven cavity has 4 different cooking levels.
 Electronic control: Allows you to maintain temperature inside the oven with the precision 2-3 ° C. This enables to cook meals that are very sensitive to temperature changes, such as cakes, souffles, puddings.	 Tilting grill: the tilting grill can be easily unhooked to move the heating element and clean the roof of the appliance in one simple step.
 Ultra rapid burners: Powerful ultra rapid burners offer up to 5kw of power.	 The capacity indicates the amount of usable space in the oven cavity in litres.



The capacity indicates the amount of usable space in the oven cavity in litres.



4.3 inch display with LED technology, usability with knobs + 3 touch keys



Knobs control

## Benefit (TT)

---

### **Gas hob**

Gas provides permanent control of the heat source and the temperature change is immediate  
Equipped with a thermocouple, the gas supply is cut off if the flame is extinguished for greater safety.

### **Ever Clean Enamel**

Easy oven cleaning thanks to special pyrolytic enamel

### **Touch control**

Easy and intuitive timer setting with a single touch

### **True-convection**

The best cooking performances guaranteed by ventilated circular flow  
Multiple fans and heating elements guarantee the perfect aerodynamic heat flow, allowing homogeneous and quicker cooking inside the cavity.

### **Multilevel cooking**

Several cooking levels allow maximum flexibility of use

### **Multilevel halogen light**

Internal halogen lighting on different levels guarantees excellent visibility

### **Removable inner glass**

Internal door glasses are easily removable for complete cleaning

### **Tangential cooling**

New cooling system with tangential fan and airflow from the door to the splashback

### **Adjustable height**

Cooker top flushed with the working area thanks to adjustable feet

### **Cold door**

During any function, the external door glass is cold, avoiding any risk of burns

### **AirFry (AIRFRY optional accessory)**

Lighter and tastier food thanks to airfry basket (optional accessory)

### **BBQ (optional accessory)**

Barbecue cooking directly in the oven with the double-sided grill (BBQ optional accessory)

**Pizza stone (optional accessory)**

Baking with refractory stone for soft and crispy pizza and yeast products (STONE optional accessory)

**Isothermic Cavity**

The best cooking performance at the highest energy efficiency

**Single turbine**

The oven has a fan equipped with a circular heating element allowing cooking with rotating heat