

# CX60SVPZ9

Cooker size	60x60 cm
N.º de cavidades com rótulo energético	1
Fonte de calor da cavidade	ELECTRICITY
Hob type	Gas
Tipo de forno principal	Thermo-ventilated
Sistema de limpeza no forno principal	No
EAN code	8017709166618
Energy efficiency class	A



## Aesthetics



<b>Aesthetic</b>	Mista	<b>Type of control setting</b>	Control knobs
<b>Serie</b>	Concerto	<b>Control knobs</b>	Smeg Classic
<b>Design</b>	Standard	<b>Controls colour</b>	Stainless steel
<b>Colour</b>	Stainless steel	<b>No. of controls</b>	7
<b>Acabamento</b>	Satin	<b>Cor da serigrafia</b>	Serigrafia em preto
<b>Command panel finish</b>	Stainless steel	<b>Door</b>	Full glass
<b>Logo</b>	Logotipo embutido	<b>Glass type</b>	Stopsol
<b>Posição do logotipo</b>	Logotipo no painel abaixo do forno	<b>Handle</b>	Smeg round handle
<b>Lid</b>	Grey glass with two strips	<b>Handle Colour</b>	Brushed stainless steel
<b>Cor da placa</b>	Stainless steel	<b>Sliding compartment</b>	No
<b>Type of pan stands</b>	Matt black enamelled flat	<b>Feet</b>	Silver

## Programs / Functions

No. of cooking functions 9

Traditional cooking functions



Static



Circulaire



Turbo



Eco



Large grill



Fan grill (large)



Grelha larga ventilada + Base



Fan assisted bottom



Pizza

Recipes

No

Cleaning functions

No

## Hob technical features

Total no. of cook zones 4

Front left - Gas - Rapid - 3.00 kW

Rear left - Gas - Semi Rapid - 1.80 kW

Rear right - Gas - Semi Rapid - 1.80 kW

Front right - Gas - AUX - 1.00 kW

Type of gas burners Standard

Gas safety valves

Yes

Automatic electronic ignition Yes

Burner caps

Matt black enamelled

## Main Oven Technical Features



No. of lights 1

Fan number 1

Net volume of the cavity 65 l

Gross volume, 1st cavity 70 l

Cavity material Ever Clean enamel

No. of shelves 5

Type of shelves Metal racks

Roof Liner No

Light type Halogen

Light Power 40 W

Cooking time setting Conta-minutos + cozimento fino

Light when oven door is open No

Removable door Yes

Full glass inner door Yes

Removable inner door Yes

Total no. of door glasses 3

No. of thermo-reflective door glasses 1

Safety Thermostat Yes

Cooling system Tangential

Usable cavity space dimensions (HxWxD) 316x444x425 mm

Temperature control Electro-mechanical

Lower heating element power 1200 W

Upper heating element - Power 1000 W

Grill element 1700 W

Large grill - Power 2700 W

Circular heating element - Power 2000 W

Grill type Electric

Tilting grill No

## Options Main Oven

Timer No

End of cooking acoustic alarm Yes

Minimum Temperature 50 °C

Maximum temperature 260 °C

## Accessories included for Main Oven & Hob

Moka stand 1

Rack com batente traseiro e lateral 1

40mm deep tray 1

Pizza Accessories Refractory stone + cover

## Electrical Connection

Plug	No
Electrical connection rating	2900 W
Current	13 A
Voltage	220-240 V

Comprimento do cabo de alimentação	115 cm
Frequency	50/60 Hz
Bloco de terminais	3 polos

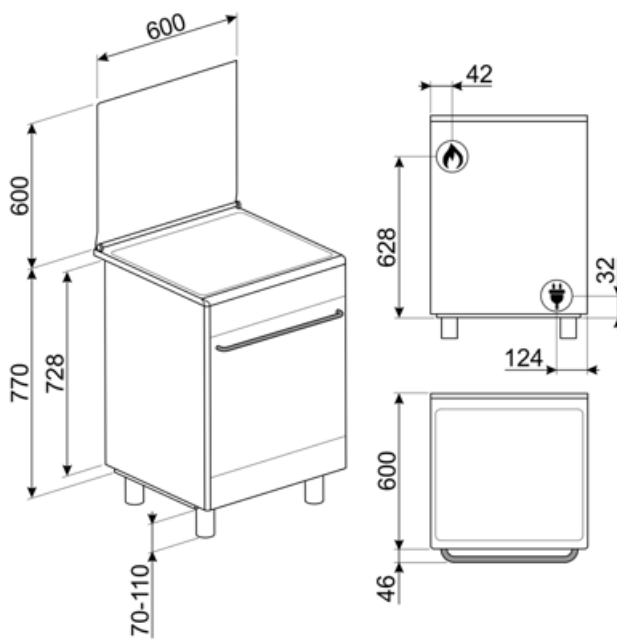

## Compatible Accessories

### AIRFRY

Air fryer rack AIRFRY . Ideal for recreating traditional frying in the oven, but with fewer calories and less fat. It allows you to cook quickly and simply dishes such as French fries, fried vegetables and fish, ensuring perfect browning and crispiness.



### BBQ

Double sided plate BBQ. Suitable for recreating succulent and crispy dishes in the oven with the typical taste of grilled cooking. The ribbed side is particularly suitable for meats and cheeses. The smooth side for fish, seafood and vegetables.



### BN620-1

Tabuleiro esmaltado, 20mm de profundidade



### BNP608T

Bandeja revestida de teflon, 8mm de profundidade, a ser colocada na grade



### GTT

\*\* Guias telescópicas totalmente extraíveis (1 nível)\*\* Extração: 433 mm Material: Aço inoxidável AISI 430 polido

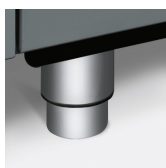

### KITPAX

Altura pés de extensão (950 mm), em aço inoxidável, adequado para fogões Master, Sinfonia e Concerto

### PALPZ

Pá para pizza com alça dobrável largura: 315mm comprimento : 325mm



### SMOLD

Conjunto de 7 moldes de silicone para sorvetes, gelados, pralinés, cubos de gelo ou para porção de alimentos. Utilizável de -60°C a +230°C

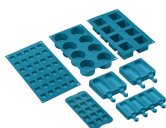

### AL60

Suporte adequado para fogões Concerto de 60 cm com placa a gás



### BG6090-1

Placa grelhadora de ferro fundido adequada para fogões Concerto



### BN640

Tabuleiro esmaltado, 40mm de profundidade



### GTP

\*\* Guias telescópicas parcialmente extraíveis (1 nível)\*\* Extração: 300 mm Material: Aço inoxidável AISI 430 polido



### KITP60X9

Painel anti-salpicos, 90 cm, aço inoxidável, adequado para fogões Concerto pirolíticos



### KITPD

Extensão de altura pés pretos (950 mm) para fogões



### SFLK1

Bloqueio para crianças

















### STONE

Pedra refratária retangular Ideal para cozinhar pizzas com os mesmos resultados de um forno típico a lenha. Também pode ser usado para assar pães, focaccias e outras receitas como tortas, flans ou biscoitos Dimensões:L42 x H1,8 x P37,5 cm.



## Symbols glossary

 R: Desempenho de secagem do produto, medido de A++ a D/G, dependendo da família de produtos	 Instalação em coluna: Instalação em coluna
 Controle dos botões	 Sistema de arrefecimento a ar: para garantir temperaturas de superfície seguras.
 Portas envidraçadas triplas: Número de portas envidraçadas.	 Interior esmaltado: O interior em esmalte de todos os fornos Smeg tem um revestimento antiácido especial que ajuda a manter o interior limpo, reduzindo a quantidade de gordura de cozimento aderente a ele.
 Circogas: Em fornos a gás, o ventilador distribui o calor de forma rápida e uniforme por toda a cavidade do forno, evitando a transferência de sabor ao cozinhar vários pratos diferentes ao mesmo tempo. Em fornos elétricos, esta combinação completa o cozimento mais rapidamente de alimentos que estão prontos na superfície, mas que exigem mais cozimento no interior, sem mais escurecimento.	 Somente elementos superior e inferior: um método de cozimento tradicional mais adequado para itens individuais localizados no centro do forno. A parte superior do forno será sempre mais quente. Ideal para assados, bolos de frutas, pão, etc.
 Circulaire: A combinação do ventilador e do elemento circular em torno dele dá um método de cozimento de ar quente. Isso oferece muitos benefícios, incluindo nenhum pré-aquecimento se o tempo de cozimento for superior a 20 minutos, nenhuma transferência de sabor ao cozinhar alimentos diferentes ao mesmo tempo, menos energia e tempos de cozimento mais curtos. Bom para todos os tipos de alimentos.	 ECO: A combinação da grelha, ventilador e elemento inferior é particularmente adequada para cozinhar pequenas quantidades de alimentos.
 Elemento de grelha O uso de grelha dá excelentes resultados ao cozinhar carne de porções médias e pequenas, especialmente quando combinada com uma rotisseria (sempre que possível). Também é ideal para cozinhar salsichas e bacon.	 Ventilador com elemento de grelha: O ventilador reduz o calor feroz da grelha, proporcionando um excelente método de grelhar vários alimentos, costeletas, bifes, salsichas, etc. dando o mesmo escurecimento e distribuição de calor, sem secar os alimentos. Os dois níveis superiores recomendados para uso e a parte inferior do forno podem ser usados para manter os itens quentes ao mesmo tempo, uma excelente facilidade ao cozinhar um café da manhã grelhado. Meia grelha (apenas porção central) é ideal para pequenas quantidades de alimentos.
 Função Pizza: Vent + grelha + inferior	 Função pizza: A operação simultânea de três elementos garante uma instalação de cozimento ideal quando usado com a pedra para pizza Smeg.



Circulaire com elementos superior e inferior: O uso do ventilador com ambos os elementos permite que os alimentos sejam cozinhados de forma rápida e eficaz, ideal para grandes peças que exigem cozimento completo. Oferece um resultado semelhante ao da rotisseria, movendo o calor em torno do alimento, em vez de mover o próprio alimento, permitindo que qualquer tamanho ou forma seja cozida.



O vidro interior da porta: pode ser removido com alguns movimentos rápidos para limpeza.



O compartimento do forno tem 5 níveis de cozimento diferentes.



Toda a porta interna de vidro: Toda a porta interna de vidro, uma única superfície plana que é simples de manter limpa.



Luzes laterais: Duas luzes laterais opostas aumentam a visibilidade dentro do forno.



A capacidade indica a quantidade de espaço útil no compartimento do forno em litros.

## Benefit (TT)

---

### **Gas hob**

Gas provides permanent control of the heat source and the temperature change is immediate  
Equipped with a thermocouple, the gas supply is cut off if the flame is extinguished for greater safety.

### **Ever Clean Enamel**

Easy oven cleaning thanks to special pyrolytic enamel

### **True-convection**

The best cooking performances guaranteed by ventilated circular flow  
Multiple fans and heating elements guarantee the perfect aerodynamic heat flow, allowing homogeneous and quicker cooking inside the cavity.

### **Multilevel cooking**

Several cooking levels allow maximum flexibility of use

### **Multilevel halogen light**

Internal halogen lighting on different levels guarantees excellent visibility

### **Removable inner glass**

Internal door glasses are easily removable for complete cleaning

### **Tangential cooling**

New cooling system with tangential fan and airflow from the door to the splashback

### **BBQ (optional accessory)**

Barbeque cooking directly in the oven with the double-sided grill (BBQ optional accessory)

### **Pizza stone (optional accessory)**

Baking with refractory stone for soft and crispy pizza and yeast products (STONE optional accessory)

### **Isothermic Cavity**

The best cooking performance at the highest energy efficiency

### **Cold door**

During any function, the external door glass is cold, avoiding any risk of burns

### **AirFry (AIRFRY optional accessory)**

Lighter and tastier food thanks to airfry basket (optional accessory)

---

### **Adjustable height**

Cooker top flushed with the working area thanks to adjustable feet

### **Single turbine**

The oven has a fan equipped with a circular heating element allowing cooking with rotating heat