

CX68MF8-2

Cooker size	60x60 cm
N.º de cavidades com rótulo energético	1
Fonte de calor da cavidade	ELECTRICITY
Hob type	Gas
Tipo de forno principal	Thermo-ventilated
Sistema de limpeza no forno principal	Vapor Clean
EAN code	8017709190194
Energy efficiency class	A



Aesthetics











Aesthetic	Classica	Type of control setting	Control knobs
Serie	Concerto	Control knobs	Smeg Classic
Design	Standard	Controls colour	Stainless steel
Colour	Stainless steel	No. of controls	7
Acabamento	Satin	Cor da serigrafia	Serigrafia em preto
Command panel finish	Stainless steel	Display	No
Logo	Logotipo embutido	Door	Full glass
Posição do logotipo	Logotipo no painel abaixo do forno	Glass type	Stopsol
Lid	No	Handle	Smeg Classic
Upstand	Yes	Handle Colour	Brushed stainless steel
Cor da placa	Stainless steel	Sliding compartment	No
Type of pan stands	Cast Iron	Feet	Silver

Programs / Functions

No. of cooking functions	8
--------------------------	---

Traditional cooking functions

 Static	 Turbo	 Eco
 Small grill	 Large grill	 Fan grill (large)
 Base	 Pizza	

Recipes

No

Cleaning functions

 Vapor clean
--

Hob technical features



Total no. of cook zones 4

Front left - Gas - UR - 3.50 kW

Rear left - Gas - Semi Rapid - 1.75 kW

Rear right - Gas - Semi Rapid - 1.75 kW

Front right - Gas - AUX - 1.00 kW

Type of gas burners Standard

Gas safety valves Yes

Automatic electronic ignition Yes

Burner caps

Matt black enamelled

Main Oven Technical Features



No. of lights	1	Removable inner door	Yes
Fan number	1	Total no. of door glasses	3
Net volume of the cavity	70 l	No. of thermo-reflective door glasses	1
Gross volume, 1st cavity	79 l	Safety Thermostat	Yes
Cavity material	Ever Clean enamel	Cooling system	Tangential
No. of shelves	5	Usable cavity space dimensions (HxWxD)	360X460X425 mm
Type of shelves	Metal racks	Temperature control	Electro-mechanical
Roof Liner	No	Lower heating element power	1200 W
Light type	Halogen	Upper heating element - Power	1000 W
Light Power	40 W	Grill element	1700 W
Cooking time setting	Stop	Large grill - Power	2700 W
Light when oven door is open	No	Circular heating element - Power	2000 W
Removable door	Yes	Grill type	Electric
Full glass inner door	Yes	Tilting grill	No

Options Main Oven

Timer	Yes	Minimum Temperature	50 °C
End of cooking acoustic alarm	Yes	Maximum temperature	260 °C

Accessories included for Main Oven & Hob

Moka stand	1	40mm deep tray	1
Rack com batente traseiro e lateral	1		

Electrical Connection

Plug	No	Electric cable	Installed, Single phase
Electrical connection rating	3000 W	Comprimento do cabo de alimentação	115 cm
Current	13 A	Frequency	50/60 Hz
Voltage	220-240 V	Bloco de terminais	3 polos

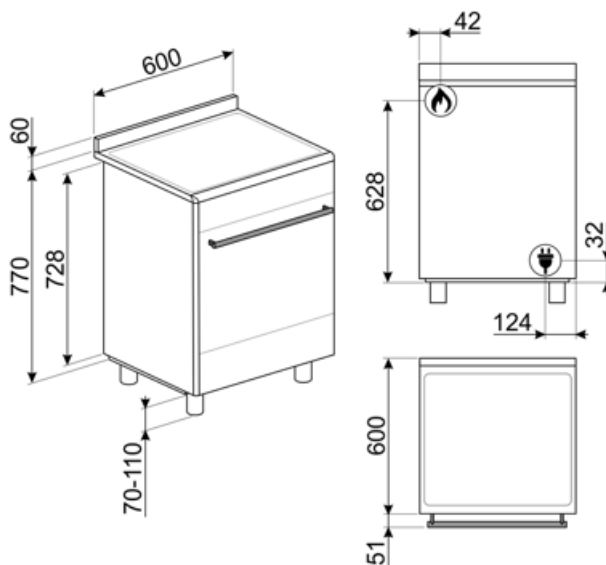

Compatible Accessories

AIRFRY

Air fryer rack AIRFRY . Ideal for recreating traditional frying in the oven, but with fewer calories and less fat. It allows you to cook quickly and simply dishes such as French fries, fried vegetables and fish, ensuring perfect browning and crispiness.



BBQ

Double sided plate BBQ. Suitable for recreating succulent and crispy dishes in the oven with the typical taste of grilled cooking. The ribbed side is particularly suitable for meats and cheeses. The smooth side for fish, seafood and vegetables.



BN620-1

Tabuleiro esmaltado, 20mm de profundidade



BNP608T

Bandeja revestida de teflon, 8mm de profundidade, a ser colocada na grade



GTT

** Guias telescópicas totalmente extraíveis (1 nível)** Extração: 433 mm
Material: Aço inoxidável AISI 430 polido



KITPAX

Altura pés de extensão (950 mm), em aço inoxidável, adequado para fogões Master, Sinfonia e Concerto



PALPZ

Pá para pizza com alça dobrável largura: 315mm comprimento : 325mm



SMOLD

Conjunto de 7 moldes de silicone para sorvetes, gelados, pralinés, cubos de gelo ou para porção de alimentos. Utilizável de -60°C a +230°C

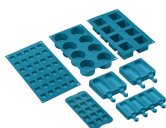

AL60

Suporte adequado para fogões Concerto de 60 cm com placa a gás



BG6090-1

Placa grelhadora de ferro fundido adequada para fogões Concerto



BN640

Tabuleiro esmaltado, 40mm de profundidade

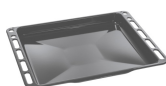

GTP

** Guias telescópicas parcialmente extraíveis (1 nível)** Extração: 300 mm Material: Aço inoxidável AISI 430 polido



KITP60X9

Painel anti-salpicos, 90 cm, aço inoxidável, adequado para fogões Concerto pirolíticos



KITPD

Extensão de altura pés pretos (950 mm) para fogões



SFLK1

Bloqueio para crianças



















STONE

Pedra refratária retangular Ideal para cozinhar pizzas com os mesmos resultados de um forno típico a lenha. Também pode ser usado para assar pães, focaccias e outras receitas como tortas, flans ou biscoitos
Dimensões:L42 x H1,8 x P37,5 cm.



Symbols glossary

	Suportes de ferro fundido para serviço pesado: para máxima estabilidade e resistência.		R: Desempenho de secagem do produto, medido de A++ a D/G, dependendo da família de produtos
	Instalação em coluna: Instalação em coluna		Controle dos botões
	Sistema de arrefecimento a ar: para garantir temperaturas de superfície seguras.		Portas envidraçadas triplas: Número de portas envidraçadas.
	Interior esmaltado: O interior em esmalte de todos os fornos Smeg tem um revestimento antiácido especial que ajuda a manter o interior limpo, reduzindo a quantidade de gordura de cozimento aderente a ele.		Somente elementos superior e inferior: um método de cozimento tradicional mais adequado para itens individuais localizados no centro do forno. A parte superior do forno será sempre mais quente. Ideal para assados, bolos de frutas, pão, etc.
	Apenas elemento de aquecimento inferior: Esta função é ideal para alimentos que exigem uma temperatura de base extra sem escurecimento, por exemplo, pratos de pastelaria, pizza. Também adequado para cozinhar lentamente ensopados e caçarolas.		ECO: A combinação da grelha, ventilador e elemento inferior é particularmente adequada para cozinhar pequenas quantidades de alimentos.
	Elemento de grelha O uso de grelha dá excelentes resultados ao cozinhar carne de porções médias e pequenas, especialmente quando combinada com uma rotisseria (sempre que possível). Também é ideal para cozinhar salsichas e bacon.		Meia grelha: Para cozinhar rapidamente e dourar os alimentos. Os melhores resultados podem ser obtidos usando a prateleira superior para itens pequenos, as prateleiras inferiores para os maiores, como costeletas ou salsichas. Para metade do calor da grelha é gerado apenas no centro do elemento, por isso é ideal para quantidades menores.
	Ventilador com elemento de grelha: O ventilador reduz o calor feroz da grelha, proporcionando um excelente método de grelhar vários alimentos, costeletas, bifes, salsichas, etc. dando o mesmo escurecimento e distribuição de calor, sem secar os alimentos. Os dois níveis superiores recomendados para uso e a parte inferior do forno podem ser usados para manter os itens quentes ao mesmo tempo, uma excelente facilidade ao cozinhar um café da manhã grelhado. Meia grelha (apenas porção central) é ideal para pequenas quantidades de alimentos.		Função pizza: A operação simultânea de três elementos garante uma instalação de cozimento ideal quando usado com a pedra para pizza Smeg.
	Circulaire com elementos superior e inferior: O uso do ventilador com ambos os elementos permite que os alimentos sejam cozinhados de forma rápida e eficaz, ideal para grandes peças que exigem cozimento completo. Oferece um resultado semelhante ao da rotisseria, movendo o calor em torno do alimento, em vez de mover o próprio alimento, permitindo que qualquer tamanho ou forma seja cozida.		Toda a porta interna de vidro: Toda a porta interna de vidro, uma única superfície plana que é simples de manter limpa.



O vidro interior da porta: pode ser removido com alguns movimentos rápidos para limpeza.



Luzes laterais: Duas luzes laterais opostas aumentam a visibilidade dentro do forno.



O compartimento do forno tem 5 níveis de cozimento diferentes.



Queimadores ultrarrápidos: Queimadores ultrarrápidos potentes oferecem até 5kw de potência.



Limpeza a Vapor: uma função de limpeza simples que utiliza vapor para afrouxar os depósitos no compartimento do forno.



A capacidade indica a quantidade de espaço útil no compartimento do forno em litros.

Benefit (TT)

Gas hob

Gas provides permanent control of the heat source and the temperature change is immediate

Equipped with a thermocouple, the gas supply is cut off if the flame is extinguished for greater safety.

Vapor Clean

By inserting water into a recess at the bottom of the cavity, steam is generated, which softens the residue and facilitates its removal

By inserting water into a recess at the bottom of the cavity, steam is generated, which softens the residue and facilitates its removal.

Knobs control

Easy and intuitive timer setting with a elegant knobs

True-convection

The best cooking performances guaranteed by ventilated circular flow

Multiple fans and heating elements guarantee the perfect aerodynamic heat flow, allowing homogeneous and quicker cooking inside the cavity.

Multilevel cooking

Several cooking levels allow maximum flexibility of use

Multilevel halogen light

Internal halogen lighting on different levels guarantees excellent visibility

Removable inner glass

Internal door glasses are easily removable for complete cleaning

Tangential cooling

New cooling system with tangential fan and airflow from the door to the splashback

BBQ (optional accessory)

Barbeque cooking directly in the oven with the double-sided grill (BBQ optional accessory)

Pizza stone (optional accessory)

Baking with refractory stone for soft and crispy pizza and yeast products (STONE optional accessory)

Cold door

During any function, the external door glass is cold, avoiding any risk of burns

AirFry (AIRFRY optional accessory)

Lighter and tastier food thanks to airfry basket (optional accessory)

Isothermic Cavity

The best cooking performance at the highest energy efficiency

Adjustable height

Cooker top flushed with the working area thanks to adjustable feet

Single turbine

The oven has a fan equipped with a circular heating element allowing cooking with rotating heat