

# CX68MF8-2

Cooker size	60x60 cm
N. of cavities with energy label	1
Cavity heat source	ELECTRICITY
Hob type	Gas
Type of main oven	Thermo-ventilated
Cleaning system main oven	Vapor Clean
EAN code	8017709190194
Energy efficiency class	A



## Aesthetics



<b>Design</b>	Standard	<b>Type of control setting hob</b>	Control knobs
<b>Command panel finish</b>	Stainless steel	<b>Type of control knobs</b>	Smeg Classic
<b>Aesthetic</b>	Classica	<b>Controls colour</b>	Stainless steel
<b>Logo</b>	Embossed	<b>No. of controls</b>	7
<b>Colour</b>	Stainless steel	<b>Serigraphy colour</b>	Black
<b>Logo position</b>	Facia below the oven	<b>Door</b>	Full glass
<b>Finishing</b>	Satin	<b>Glass type</b>	Stopsol
<b>Upstand</b>	Yes	<b>Handle</b>	Smeg Classic
<b>Series</b>	Concerto	<b>Handle Colour</b>	Brushed stainless steel
<b>Hob colour</b>	Stainless steel	<b>Feet color</b>	Silver
<b>Type of pan stands</b>	Cast Iron		

## Programs / Functions main oven

No. of cooking functions 8

Traditional cooking functions

Static	Turbo	Eco
Small grill	Large grill	Fan grill (large)
Base	Pizza	

## Cleaning functions

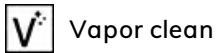

## Hob technical features



**Total no. of cook zones** 4

Front left - Gas - UR - 3.50 kW

Rear left - Gas - Semi Rapid - 1.75 kW

Rear right - Gas - Semi Rapid - 1.75 kW

Front right - Gas - AUX - 1.00 kW

**Type of gas burners** Standard

**Gas safety valves** Yes

**Automatic electronic ignition** Yes

**Burner caps** Matt black enamelled

## Main Oven Technical Features



**No. of lights** 1

**Fan number** 1

**Net volume of the cavity** 70 l

**Gross volume, 1st cavity** 79 l

**Cavity material** Ever Clean enamel

**No. of shelves** 5

**Type of shelves** Metal racks

**Light type** Halogen

**Light Power** 40 W

**Cooking time setting** Stop

**Removable door** Yes

**Full glass inner door** Yes

**Removable inner door** Yes

**Total no. of door glasses** 3

**No. of thermo-reflective door glasses** 1

**Safety Thermostat** Yes

**Cooling system** Tangential

**Usable cavity space dimensions (HxWxD)** 360X460X425 mm

**Temperature control** Electro-mechanical

**Lower heating element power** 1200 W

**Upper heating element - Power** 1000 W

**Grill element** 1700 W

**Large grill - Power** 2700 W

**Circular heating element - Power** 2000 W

**Grill type** Electric

## Options Main Oven

**Timer** Yes

**End of cooking acoustic alarm** Yes

**Minimum Temperature** 50 °C

**Maximum temperature** 260 °C

## Accessories included for Main Oven & Hob

**Moka stand** 1

**40mm deep tray** 1

Rack with back and side 1  
stop

## Electrical Connection

Electrical connection rating	3000 W	Power supply cable length	115 cm
Current	13 A	Frequency	50/60 Hz
Voltage	220-240 V	Terminal block	3 poles
Electric cable	Installed, Single phase	Plug	Not present

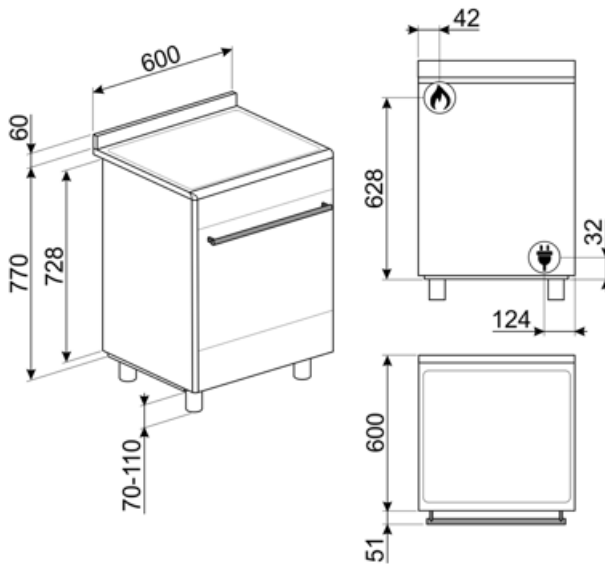

## Compatible Accessories

### AIRFRY

Air fryer rack AIRFRY. Ideal for recreating traditional frying in the oven, but with fewer calories and less fat. It allows you to cook quickly and simply dishes such as French fries, fried vegetables and fish, ensuring perfect browning and crispiness.



### AL60

Upstand suitable for 60cm Concert cookers with gas hob MF oven



### BN620-1

Enamelled tray suitable for 45 cm and 60 cm ovens. Depth 20 mm. Perfect for a wide range of savoury and sweet baking.



### BNP608T

Teflon-coated tray, 8 mm depth, to be placed on the grid



### GTT

Totally extractable telescopic guides (1 level), suitable for traditional ovens. Made in stainless steel, they guarantee stability and facilitate the smooth extraction of the trays.



### KITPAX

High extension feet, stainless steel, (950mm) suitable for Master, Sinfonia and Portofino 90cm cookers (914-968mm); High extension feet (900mm), st/steel, suitable for Concerto cookers with 850mm height (880-935mm)

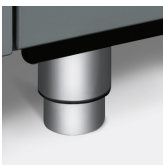

### PALPZ

Pizza shovel with folding handle. Dimensions L31.5 x H32.5 cm. Easy and convenient to use and store. Perfect for serving pizza, bread and savory pastries in a safe and professional way.



### AIRFRY2

Air fryer tray. Ideal for recreating traditional frying in the oven, but with fewer calories and less fat. It allows you to cook quickly and simply dishes such as French fries, fried vegetables and fish, ensuring perfect browning and crispiness.



### BBQ

Double sided plate BBQ. Suitable for recreating succulent and crispy dishes in the oven with the typical taste of grilled cooking. The ribbed side is particularly suitable for meats and cheeses. The smooth side for fish, seafood and vegetables.



### BN640

Enamelled tray suitable for 45cm and 60cm ovens. Depth 540 mm. Perfect for cooking and roasting meat and fish in sauces. Also ideal for experimenting with lighter and crunchy side dishes



### GTP

Partially extractable telescopic guides (1 level), suitable for traditional ovens. Made in stainless steel, they guarantee stability and facilitate the smooth extraction of the trays.



### KITP60X9

Splashback, stainless steel, suitable for 60X60cm Concerto cookers with pyro and MF oven



### KITPD

High extension black feet (950 mm), black, suitable for Master, Sinfonia and Portofino 90cm (914-968mm); High extension black feet (900 mm), black, suitable for Concerto cookers with 850mm height (880-935mm)



### SFLK1

Child lock



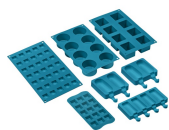

### SMOLD

















Set of 7 silicone moulds for ice creams, ice lollies, pralines, ice cubes or to portion food. Usable from -60°C to +230°C









### STONE

Rectangular refractory stone Ideal for cooking pizzas with the same results as a typical wood-fired oven. Can also be used for baking bread, focaccias and other recipes such as pies, flans or biscuits Dimensions:L42 x H1,8 x P37,5 cm.

## Symbols glossary

 <p>Heavy duty cast iron pan stands: for maximum stability and strength.</p>	 <p>Energy efficiency class A</p>
 <p>Installation in column: Installation in column.</p>	 <p>Air cooling system: to ensure a safe surface temperatures.</p>
 <p>Triple glazed doors: Number of glazed doors.</p>	 <p>Ever Clean Enamel: Ever Clean enamel is applied electrostatically, corner to corner and edge to edge to prevent cracking or cracks over time. It is a particular pyrolytic enamel, resistant to acids which, in addition to being pleasantly bright, promotes greater cleaning of the oven walls, thanks to its lower porosity. It is baked at over 850 °C and slowly polymerized at a scientifically determined rate to ensure uniform depth and strength. Ever Clean enamel creates an impeccable finish both on the inside of the oven and on the trays, making the surfaces of the oven incredibly easy to maintain over time as it reduces the adhesion of fat during cooking.</p>
 <p>Static: Traditional cooking suitable for the preparation of one dish at a time. The fan is not active and the heat comes from below and from above at the same time. Static cooking is slower and more delicate, ideal in order to get well cooked and dry dishes even inside. Ideal for cooking all types of roasts, fatty meats, bread, filled cakes.</p>	 <p>Base: the heat comes only from the bottom of the cavity. The fan is not active. Ideal for sweet and savory pies, cobblers and pizzas. Designed to complete cooking and make food more crunchy. This symbol in gas ovens indicates the gas burner.</p>
 <p>ECO: low energy consumption cooking: this function is particularly suitable for cooking on a single shelf with low energy consumption. It is recommended for all types of food except those that can generate a lot of moisture (for example vegetables). To achieve maximum energy savings and reduce time, it is recommended to put the food in the oven without preheating the cooking compartment.</p>	 <p>Grill: Very intense heat coming only from above from a double heating element. The fan is not active. Provides excellent grilling and gratinating results. Used at the end of cooking, it gives a uniform browning to dishes.</p>
 <p>Half grill: For rapid cooking and browning of foods. Best results can be obtained by using the top shelf for small items, the lower shelves for larger ones, such as chops or sausages. For half grill heat is generated only at the centre of the element, so is ideal for smaller quantities.</p>	 <p>Fan grill: very intense heat coming only from above from a double heating element. The fan is active. It allows the optimal grilling of thickest meats. Ideal for large cuts of meat.</p>
 <p>Pizza function: Specific function for cooking pizza in a pan. It allows to obtain a pizza that is soft inside and crispy outside with the topping perfectly cooked, not dry and not burnt.</p>	 <p>Turbo: the heat comes from 3 directions: above, below and from the back of the oven. The fan is active. It allows quick cooking, even on several shelves without mixing the aromas. Ideal for large volumes or foods that require intense cooking.</p>
 <p>All glass inner door: All glass inner door, a single flat surface which is simple to keep clean.</p>	 <p>The inner door glass: can be removed with a few quick movements for cleaning.</p>

- 
-  Side lights: Two opposing side lights increase visibility inside the oven.
  -  The oven cavity has 5 different cooking levels.
  -  Ultra rapid burners: Powerful ultra rapid burners offer up to 5kw of power.
  -  Vapor Clean: a simple cleaning function using steam to loosen deposits in the oven cavity.
  -  The capacity indicates the amount of usable space in the oven cavity in litres.
  -  Knobs control