

CX92IM

Cooker size	90x60 cm
N.º de cavidades com rótulo energético	2
Fonte de calor da cavidade	ELECTRICITY
Hob type	Induction
Tipo de forno principal	Thermo-ventilated
Type of second oven	Static
Sistema de limpeza no forno principal	Vapor Clean
EAN code	8017709341398
Energy efficiency class	A
Energy efficiency class, second cavity	A



Aesthetics



Aesthetic	Classica	Control knobs	Smeg Classic
Serie	Concerto	Controls colour	Stainless steel
Design	Standard	No. of controls	4
Colour	Stainless steel	Cor da serigrafia	Serigrafia em prateado
Acabamento	Satin	Display	Touch
Command panel finish	Stainless steel	Door	Full glass
Logo	Logotipo embutido	Glass type	Black
Posição do logotipo	Logotipo no painel abaixo do forno	Handle	Smeg Classic
Upstand	No	Handle Colour	Brushed stainless steel
Cor da placa	Stainless steel	Storage compartment	Door
Type of control setting	Touch controls	Feet	Black
Comandos Slider	Branco		

Programs / Functions

No. of cooking functions	6
Traditional cooking functions	

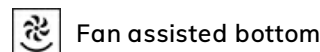
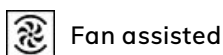

Cleaning functions

 Vapor clean

Programs / Functions Auxiliary Oven

Funções de cozedura cavidade 2 4

Funções tradicionais de cozimento, cavidade 2

 Static

 Small grill

 Large grill

 Fundo

Defrost No

Pyrolysis No

Vapor Clean No

Hob technical features



Total no. of cook zones 4

Front left - Induction - single - 2.30 kW - Booster 3.00 kW - Ø 21.0 cm

Rear left - Induction - single - 1.30 kW - Booster 1.40 kW - Ø 18.0 cm

Rear right - Induction - giant - 2.30 kW - Booster 3.00 kW - Ø 21.0 cm

Front right - Induction - single - 1.30 kW - Booster 1.40 kW - Ø 18.0 cm

Main Oven Technical Features



No. of lights 1

Fan number 1

Net volume of the cavity 70 l

Gross volume, 1st cavity 79 l

Cavity material Ever Clean enamel

No. of shelves 5

Type of shelves Metal racks

Light type Halogen

Light Power 40 W

Cooking time setting Start and Stop

Light when oven door is open Yes

Door opening Flap down

Removable door Yes

Full glass inner door Yes

Removable inner door Yes

Total no. of door glasses 3

No. of thermo-reflective door glasses 1

Safety Thermostat Yes

Cooling system Tangential

Usable cavity space dimensions (HxWxD) 360X460X425 mm

Temperature control Electro-mechanical

Lower heating element power 1200 W

Upper heating element - Power 1000 W

Grill element 1700 W

Circular heating element - Power 2000 W

Grill type Electric

Options Main Oven

Timer	Yes	Minimum Temperature	50 °C
End of cooking acoustic alarm	Yes	Maximum temperature	260 °C

Second Oven Technical Features



Net volume of the second cavity	35 l	Removable inner door	Yes
Gross volume, 2nd cavity	36 l	No. total door glasses	3
Cavity material	Ever Clean enamel	No. thermo-reflective door glasses	1
No. of shelves	4	Safety Thermostat	Yes
Type of shelves	Metal racks	Cooling system	Tangential
No. of lights	1	Usable cavity space dimensions (HxWxD)	311x206x418 mm
Light type	Incandescent	Temperature control	Electro-mechanical
Light Power	25 W	Lower heating element - power	700 W
Cooking time setting	No	Upper heating element - Power	600 W
Door opening	Flap down	Grill element - power	1300 W
Removable door	Yes	Large grill - Power	1900 W
Full glass inner door	Yes	Grill type	Electric

Options Auxiliary Oven

Timer	No	Minimum Temperature	50 °C
End of cooking acoustic alarm	No	Maximum temperature	245 °C

Accessories included for Main Oven & Hob

Rack com batente traseiro e lateral	1	40mm deep tray	1
20mm deep tray	1	Grill mesh	1

Accessories included for Secondary Oven

Rack com batente traseiro e lateral	1	Grill mesh	1
Wide baking tray	1		

Electrical Connection

Plug	No	Electric cable	Installed, Single phase
Electrical connection rating	11000 W	Type of electric cable	Double and Three Phase
Current	33 A	Frequency	50/60 Hz
Voltage	220-240 V	Bloco de terminais	5 polos
Voltage 2 (V)	380-415 V		

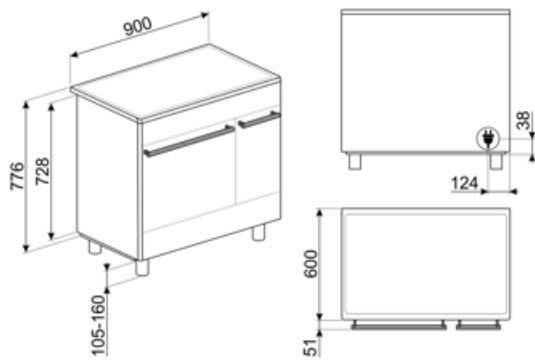

Compatible Accessories

AIRFRY

Air fryer rack AIRFRY . Ideal for recreating traditional frying in the oven, but with fewer calories and less fat. It allows you to cook quickly and simply dishes such as French fries, fried vegetables and fish, ensuring perfect browning and crispiness.



BBQ

Double sided plate BBQ. Suitable for recreating succulent and crispy dishes in the oven with the typical taste of grilled cooking. The ribbed side is particularly suitable for meats and cheeses. The smooth side for fish, seafood and vegetables.



BN640

Tabuleiro esmaltado, 40mm de profundidade



GTP

** Guias telescópicas parcialmente extraíveis (1 nível)** Extração: 300 mm
Material: Aço inoxidável AISI 430 polido



AL90X9

Suporte adequado para fogões Concerto de 90 cm SX91



BN620-1

Tabuleiro esmaltado, 20mm de profundidade



BNP608T

Bandeja revestida de teflon, 8mm de profundidade, a ser colocada na grade



GTT

** Guias telescópicas totalmente extraíveis (1 nível)** Extração: 433 mm
Material: Aço inoxidável AISI 430 polido

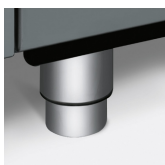

KITH95

Kit extensão de altura (950 mm), aço inoxidável



KITPDQ

Pés de redução de altura (850 mm), de aço inoxidável, para fogões



SCRP

Placas de indução e de cerâmica e raspador teppanyaki

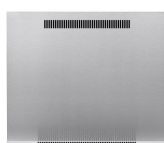

KITPC92X9

Painel anti-salpicos, 90x60 cm, aço inoxidável, para fogões Concerto, cavidade pirolítica dupla



PALPZ

Pá para pizza com alça dobrável largura: 315mm comprimento : 325mm



SFLK1

Bloqueio para crianças

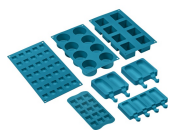

SMOLD



















Conjunto de 7 moldes de silicone para sorvetes, gelados, pralinés, cubos de gelo ou para porção de alimentos. Utilizável de -60°C a +230°C













STONE

Pedra refratária retangular Ideal para cozinhar pizzas com os mesmos resultados de um forno típico a lenha. Também pode ser usado para assar pães, focaccias e outras receitas como tortas, flans ou biscoitos
Dimensões:L42 x H1,8 x P37,5 cm.

Symbols glossary

 <p>R: Desempenho de secagem do produto, medido de A++ a D/G, dependendo da família de produtos</p>	 <p>Instalação em coluna: Instalação em coluna</p>
 <p>Sistema de arrefecimento a ar: para garantir temperaturas de superfície seguras.</p>	 <p>Portas envidraçadas triplas: Número de portas envidraçadas.</p>
 <p>ECO-logic: opção permite-lhe restringir o limite de potência da poupança de energia real do aparelho.</p>	 <p>Interior esmaltado: O interior em esmalte de todos os fornos Smeg tem um revestimento antiácido especial que ajuda a manter o interior limpo, reduzindo a quantidade de gordura de cozimento aderente a ele.</p>
 <p>Circogas: Em fornos a gás, o ventilador distribui o calor de forma rápida e uniforme por toda a cavidade do forno, evitando a transferência de sabor ao cozinhar vários pratos diferentes ao mesmo tempo. Em fornos elétricos, esta combinação completa o cozimento mais rapidamente de alimentos que estão prontos na superfície, mas que exigem mais cozimento no interior, sem mais escurecimento.</p>	 <p>Ventilador com elementos superiores e inferiores: Os elementos combinados com o ventilador visam fornecer calor mais uniforme, um método semelhante ao cozimento convencional, de modo que o pré-aquecimento é necessário. Mais adequado para itens que exigem métodos de cozimento lento.</p>
 <p>Somente elementos superior e inferior: um método de cozimento tradicional mais adequado para itens individuais localizados no centro do forno. A parte superior do forno será sempre mais quente. Ideal para assados, bolos de frutas, pão, etc.</p>	 <p>Apenas elemento de aquecimento inferior: Esta função é ideal para alimentos que exigem uma temperatura de base extra sem escurecimento, por exemplo, pratos de pasteleria, pizza. Também adequado para cozinhar lentamente ensopados e caçarolas.</p>
 <p>Circulaire: A combinação do ventilador e do elemento circular em torno dele dá um método de cozimento de ar quente. Isso oferece muitos benefícios, incluindo nenhum pré-aquecimento se o tempo de cozimento for superior a 20 minutos, nenhuma transferência de sabor ao cozinhar alimentos diferentes ao mesmo tempo, menos energia e tempos de cozimento mais curtos. Bom para todos os tipos de alimentos.</p>	 <p>ECO: A combinação da grelha, ventilador e elemento inferior é particularmente adequada para cozinhar pequenas quantidades de alimentos.</p>
 <p>Elemento de grelha O uso de grelha dá excelentes resultados ao cozinhar carne de porções médias e pequenas, especialmente quando combinada com uma rotisseria (sempre que possível). Também é ideal para cozinhar salsichas e bacon.</p>	 <p>Meia grelha: Para cozinhar rapidamente e dourar os alimentos. Os melhores resultados podem ser obtidos usando a prateleira superior para itens pequenos, as prateleiras inferiores para os maiores, como costeletas ou salsichas. Para metade do calor da grelha é gerado apenas no centro do elemento, por isso é ideal para quantidades menores.</p>
 <p>Luz</p>	 <p>Zona gigante: A zona gigante oferece espaço extra e flexibilidade.</p>
 <p>Indução: O trabalho destas placas baseia-se no princípio da indução electromagnética. O calor é gerado diretamente na parte inferior da panela durante o seu contato com a placa.</p>	 <p>Toda a porta interna de vidro: Toda a porta interna de vidro, uma única superfície plana que é simples de manter limpa.</p>

-
- | | |
|--|--|
|  <p>O vidro interior da porta: pode ser removido com alguns movimentos rápidos para limpeza.</p> |  <p>Luzes laterais: Duas luzes laterais opostas aumentam a visibilidade dentro do forno.</p> |
|  <p>Abertura automática: alguns modelos têm porta de abertura automática quando o ciclo é terminado, o que é uma solução perfeita para unidades de cozinha sem alça, pois nenhuma alça é necessária. Por razões de segurança, a porta trava automaticamente quando a máquina está em uso para evitar que seja aberta inadvertidamente.</p> |  <p>O compartimento do forno tem 4 níveis de cozimento diferentes.</p> |
|  <p>O compartimento do forno tem 5 níveis de cozimento diferentes.</p> |  <p>Comando eletrônico. Permite manter a temperatura no interior do forno com a precisão de 2-3 ° C. Isso permite cozinhar refeições que são muito sensíveis a mudanças de temperatura, como por ex. bolos, suflês, pudins.</p> |
|  <p>Limpeza a Vapor: uma função de limpeza simples que utiliza vapor para afrouxar os depósitos no compartimento do forno.</p> |  <p>A capacidade indica a quantidade de espaço útil no compartimento do forno em litros.</p> |
|  <p>A capacidade indica a quantidade de espaço útil no compartimento do forno em litros.</p> |  <p>...</p> |
|  <p>Touch Control</p> | |

Benefit (TT)

Induction hob

Induction offers fast cooking and precise temperature control

Through the use of suitable cookware, induction is easy to use and maintain, safe and responsive.

Vapor Clean

By inserting water into a recess at the bottom of the cavity, steam is generated, which softens the residue and facilitates its removal

By inserting water into a recess at the bottom of the cavity, steam is generated, which softens the residue and facilitates its removal.

Touch control

Easy and intuitive timer setting with a single touch

Storage compartment

More space thanks to the lower compartment, ideal for storing accessories or cooking utensils

True-convection

The best cooking performances guaranteed by ventilated circular flow

Multiple fans and heating elements guarantee the perfect aerodynamic heat flow, allowing homogeneous and quicker cooking inside the cavity.

Multilevel cooking

Several cooking levels allow maximum flexibility of use

Multilevel halogen light

Internal halogen lighting on different levels guarantees excellent visibility

Removable inner glass

Internal door glasses are easily removable for complete cleaning

Tangential cooling

New cooling system with tangential fan and airflow from the door to the splashback

Isothermic Cavity

The best cooking performance at the highest energy efficiency

Adjustable height

Cooker top flushed with the working area thanks to adjustable feet

AirFry (AIRFRY optional accessory)

Lighter and tastier food thanks to airfry basket (optional accessory)

Cold door

During any function, the external door glass is cold, avoiding any risk of burns

Pizza stone (optional accessory)

Baking with refractory stone for soft and crispy pizza and yeast products (STONE optional accessory)

BBQ (optional accessory)

Barbeque cooking directly in the oven with the double-sided grill (BBQ optional accessory)

Single turbine

The oven has a fan equipped with a circular heating element allowing cooking with rotating heat