

# CX93GMBL

Cooker size	90x60 cm
N. of cavities with energy label	2
Cavity heat source	ELECTRICITY
Hob type	Gas
Type of main oven	Thermo-ventilated
Type of second oven	Thermo-ventilated
Cleaning system main oven	Ever Clean enamel
EAN code	8017709334536
Energy efficiency class	A
Energy efficiency class, second cavity	B



## Aesthetics



<b>Design</b>	Standard	<b>Type of control knobs</b>	Smeg Classic
<b>Command panel finish</b>	Enamelled metal	<b>Controls colour</b>	Stainless steel
<b>Aesthetic</b>	Classica	<b>No. of controls</b>	8
<b>Logo</b>	Silk screen	<b>Serigraphy colour</b>	Silver
<b>Colour</b>	Black	<b>Display name</b>	DigiScreen
<b>Logo position</b>	Command panel	<b>Door</b>	Full glass
<b>Finishing</b>	Glossy black	<b>Glass type</b>	Black
<b>Series</b>	Concerto	<b>Handle</b>	Smeg Classic
<b>Hob colour</b>	Black enamel	<b>Handle Colour</b>	Polished stainless steel
<b>Type of pan stands</b>	Cast Iron	<b>Feet color</b>	Black
<b>Type of control setting hob</b>	Control knobs		

## Programs / Functions main oven

No. of cooking functions	1
Traditional cooking functions	

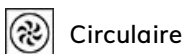

Circulaire

## Programs / Functions auxiliary oven

Cooking functions cavity 2	1
----------------------------	---

## Programs / Functions third oven

No. of functions third oven

1

Full grill



## Hob technical features

			
<b>Total no. of cook zones</b> 5			
Front left - Gas - Rapid - 2.90 kW			
Rear left - Gas - Semi Rapid - 1.80 kW			
Central - Gas - UR - 4.00 kW			
Rear right - Gas - Semi Rapid - 1.80 kW			
Front right - Gas - AUX - 1.00 kW			
<b>Type of gas burners</b>	Standard	<b>Gas safety valves</b>	Yes
<b>Automatic electronic ignition</b>	Yes	<b>Burner caps</b>	Matt black enamelled

## Main Oven Technical Features



<b>No. of lights</b>	1	<b>Removable door</b>	Yes
<b>Fan number</b>	1	<b>Full glass inner door</b>	Yes
<b>Net volume of the cavity</b>	61 l	<b>Removable inner door</b>	Yes
<b>Gross volume, 1st cavity</b>	70 l	<b>Total no. of door glasses</b>	3
<b>Cavity material</b>	Ever Clean enamel	<b>No. of thermo-reflective door glasses</b>	1
<b>No. of shelves</b>	4	<b>Safety Thermostat</b>	Yes
<b>Type of shelves</b>	Metal racks	<b>Cooling system</b>	Tangential
<b>Light type</b>	Halogen	<b>Usable cavity space dimensions (HxWxD)</b>	316x460x412 mm
<b>Light Power</b>	40 W	<b>Temperature control</b>	Electro-mechanical
<b>Cooking time setting</b>	Start and Stop	<b>Circular heating element - Power</b>	2000 W
<b>Door opening</b>	Side opening		

## Options Main Oven

<b>Timer</b>	Yes	<b>Minimum Temperature</b>	50 °C
<b>End of cooking acoustic alarm</b>	Yes	<b>Maximum temperature</b>	245 °C

## Second Oven Technical Features



<b>Fan number</b>	1	<b>Full glass inner door</b>	Yes
<b>Net volume of the second cavity</b>	62 l	<b>No. total door glasses</b>	2
<b>Gross volume, 2nd cavity</b>	69 l	<b>No. thermo-reflective door glasses</b>	1
<b>Cavity material</b>	Ever Clean enamel	<b>Safety Thermostat</b>	Yes
<b>No. of shelves</b>	9	<b>Cooling system</b>	Tangential
<b>Type of shelves</b>	Metal racks	<b>Usable cavity space dimensions (HxWxD)</b>	605x275x370 mm
<b>Door opening</b>	Side opening	<b>Temperature control</b>	Electro-mechanical
<b>Removable door</b>	Yes	<b>Circular heating element - Power</b>	2500 W

## Options Auxiliary Oven

<b>Minimum Temperature</b>	50 °C	<b>Maximum temperature</b>	245 °C
----------------------------	-------	----------------------------	--------

## Third Oven Technical Features



<b>Net volume, 3rd cavity</b>	35 l	<b>No. total door glasses</b>	3
<b>Gross volume, 3rd cavity</b>	41 l	<b>No. of thermo-reflective door glasses</b>	1
<b>Cavity material</b>	Ever Clean enamel	<b>Safety Thermostat</b>	Yes
<b>No. of shelves</b>	2	<b>Cooling system</b>	Tangential
<b>Type of shelves</b>	Metal racks	<b>Usable cavity space dimensions (HxWxD)</b>	169x440x443 mm
<b>Door opening</b>	Flap down	<b>Temperature control</b>	Electro-mechanical
<b>Removable door</b>	Yes	<b>Large grill - Power</b>	2700 W
<b>Full glass inner door</b>	Yes	<b>Grill type</b>	Electric
<b>Removable inner door</b>	Yes	<b>Tilting grill</b>	Yes

## Options Third Oven

<b>Minimum Temperature</b>	50 °C	<b>Maximum temperature</b>	260 °C
----------------------------	-------	----------------------------	--------

## Accessories included for Main Oven & Hob

<b>Rack with back and side stop</b>	1	<b>40mm deep tray</b>	1
-------------------------------------	---	-----------------------	---

## Accessories included for Secondary Oven

<b>Oven grid with back stop</b>	3
---------------------------------	---

## Electrical Connection

<b>Electrical connection rating</b>	7600 W	<b>Additional connection modalities</b>	Double and Three Phase
<b>Current</b>	33 A	<b>Frequency</b>	50/60 Hz
<b>Voltage</b>	220-240 V	<b>Terminal block</b>	5 poles
<b>Voltage 2 (V)</b>	380-415 V	<b>Plug</b>	Not present
<b>Cable testing</b>	Yes, Single phase		

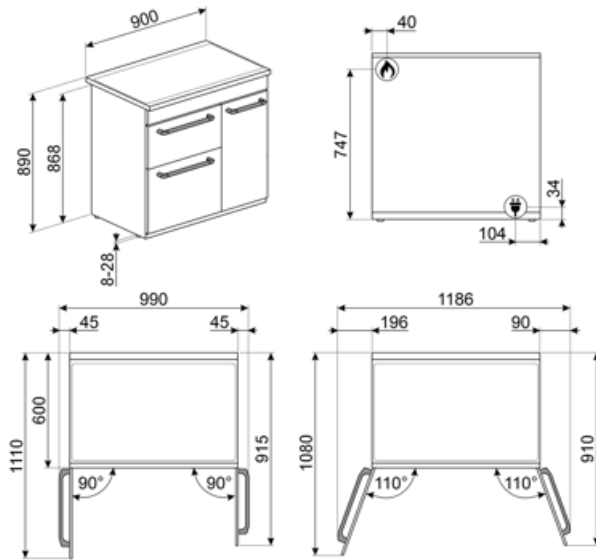

## Compatible Accessories

### AIRFRY

Air fryer rack AIRFRY. Ideal for recreating traditional frying in the oven, but with fewer calories and less fat. It allows you to cook quickly and simply dishes such as French fries, fried vegetables and fish, ensuring perfect browning and crispiness.



### BBQ

Double sided plate BBQ. Suitable for recreating succulent and crispy dishes in the oven with the typical taste of grilled cooking. The ribbed side is particularly suitable for meats and cheeses. The smooth side for fish, seafood and vegetables.



### BN640

Enamelled tray suitable for 45cm and 60cm ovens. Depth 540 mm. Perfect for cooking and roasting meat and fish in sauces. Also ideal for experimenting with lighter and crunchy side dishes



### GRM

Coffee machine support



### GTT

Totally extractable telescopic guides (1 level), suitable for traditional ovens. Made in stainless steel, they guarantee stability and facilitate the smooth extraction of the trays.



### KITH93

Height extension kit (950mm), black, suitable for TR93 cookers (945-960mm)



### SFLK1

Child lock



### AIRFRY2

Air fryer tray. Ideal for recreating traditional frying in the oven, but with fewer calories and less fat. It allows you to cook quickly and simply dishes such as French fries, fried vegetables and fish, ensuring perfect browning and crispiness.



### BN620-1

Enamelled tray suitable for 45 cm and 60 cm ovens. Depth 20 mm. Perfect for a wide range of savoury and sweet baking.



### BNP608T

Teflon-coated tray, 8 mm depth, to be placed on the grid



### GTP

Partially extractable telescopic guides (1 level), suitable for traditional ovens. Made in stainless steel, they guarantee stability and facilitate the smooth extraction of the trays.



### KIT90N9

Splashback black , 90 cm, suitable for BU & BM cookers



### PALPZ

Pizza shovel with folding handle. Dimensions L31.5 x H32.5 cm. Easy and convenient to use and store. Perfect for serving pizza, bread and savory pastries in a safe and professional way.



### SMOLD

Set of 7 silicone moulds for ice creams, ice lollies, pralines, ice cubes or to portion food. Usable from -60°C to +230°C

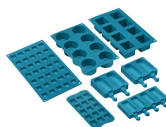

## STONE

Rectangular refractory stone Ideal for cooking pizzas with the same results as a typical wood-fired oven. Can also be used for baking bread, focaccias and other recipes such as pies, flans or biscuits Dimensions:L42 x H1,8 x P37,5 cm.



























## WOKGHU

Cast iron WOK Support



## Symbols glossary

	Energy efficiency class A		B: Product energy rating, measured from A+++ to D / G depending on the product family.
	Heavy duty cast iron pan stands: for maximum stability and strength.		Installation in column: Installation in column.
	Air cooling system: to ensure a safe surface temperatures.		Double glazed doors: Number of glazed doors.
	Triple glazed doors: Number of glazed doors.		Ever Clean Enamel: Ever Clean enamel is applied electrostatically, corner to corner and edge to edge to prevent cracking or cracks over time. It is a particular pyrolytic enamel, resistant to acids which, in addition to being pleasantly bright, promotes greater cleaning of the oven walls, thanks to its lower porosity. It is baked at over 850 °C and slowly polymerized at a scientifically determined rate to ensure uniform depth and strength. Ever Clean enamel creates an impeccable finish both on the inside of the oven and on the trays, making the surfaces of the oven incredibly easy to maintain over time as it reduces the adhesion of fat during cooking.
	Circulaire: it is the perfect function for cooking all types of dishes in a more delicate way. The heat comes from the back of the oven and is distributed quickly and evenly. The fan is active. It is also ideal for cooking on multiple levels without mixing smells and flavors.		Grill element: Using of grill gives excellent results when cooking meat of medium and small portions, especially when combined with a rotisserie (where possible). Also ideal for cooking sausages and bacon.
	All glass inner door: All glass inner door, a single flat surface which is simple to keep clean.		The inner door glass: can be removed with a few quick movements for cleaning.
	Side lights: Two opposing side lights increase visibility inside the oven.		The oven cavity has 2 different cooking levels.
	The oven cavity has 4 different cooking levels.		The oven cavity has 9 different cooking levels.
	Electronic control: Allows you to maintain temperature inside the oven with the precision 2-3 ° C. This enables to cook meals that are very sensitive to temperature changes, such as cakes, souffles, puddings.		Tilting grill: the tilting grill can be easily unhooked to move the heating element and clean the roof of the appliance in one simple step.
	Ultra rapid burners: Powerful ultra rapid burners offer up to 5kw of power.		The capacity indicates the amount of usable space in the oven cavity in litres.
	The capacity indicates the amount of usable space in the oven cavity in litres.		The capacity indicates the amount of usable space in the oven cavity in litres.
	4.3 inch display with LED technology, usability with knobs + 3 touch keys		Knobs control

---

## Benefit (TT)

---

### **Gas hob**

Gas provides permanent control of the heat source and the temperature change is immediate  
Equipped with a thermocouple, the gas supply is cut off if the flame is extinguished for greater safety.

### **Ever Clean Enamel**

Easy oven cleaning thanks to special pyrolytic enamel

### **Touch control**

Easy and intuitive timer setting with a single touch

### **True-convection**

The best cooking performances guaranteed by ventilated circular flow  
Multiple fans and heating elements guarantee the perfect aerodynamic heat flow, allowing homogeneous and quicker cooking inside the cavity.

### **Multilevel cooking**

Several cooking levels allow maximum flexibility of use

### **Multilevel halogen light**

Internal halogen lighting on different levels guarantees excellent visibility

### **Removable inner glass**

Internal door glasses are easily removable for complete cleaning

### **Tangential cooling**

New cooling system with tangential fan and airflow from the door to the splashback

### **Adjustable height**

Cooker top flushed with the working area thanks to adjustable feet

### **Cold door**

During any function, the external door glass is cold, avoiding any risk of burns

### **AirFry (AIRFRY optional accessory)**

Lighter and tastier food thanks to airfry basket (optional accessory)

### **BBQ (optional accessory)**

Barbecue cooking directly in the oven with the double-sided grill (BBQ optional accessory)

**Pizza stone (optional accessory)**

Baking with refractory stone for soft and crispy pizza and yeast products (STONE optional accessory)

**Isothermic Cavity**

The best cooking performance at the highest energy efficiency

**Single turbine**

The oven has a fan equipped with a circular heating element allowing cooking with rotating heat