

CX93IMBL

Cooker size	90x60 cm
N.º de cavidades com rótulo energético	2
Fonte de calor da cavidade	ELECTRICITY
Hob type	Induction
Tipo de forno principal	Thermo-ventilated
Type of second oven	Thermo-ventilated
Sistema de limpeza no forno principal	No
EAN code	8017709340636
Energy efficiency class	A
Energy efficiency class, second cavity	B



Aesthetics



Aesthetic	Classica	Control knobs	Smeg Classic
Serie	Concerto	Controls colour	Stainless steel
Design	Standard	No. of controls	8
Colour	Black	Cor da serigrafia	Serigrafia em prateado
Acabamento	Glossy black	Display	Touch
Command panel finish	Enamelled metal	Door	With frame
Logo	Logotipo aplicado	Glass type	Black
Posição do logotipo	Logotipo no painel de comandos	Handle	Smeg Classic
Upstand	No	Handle Colour	Brushed stainless steel
Cor da placa	Esmalte preto	Feet	Black
Type of control setting	Hybrid: Knobs + Touch		

Programs / Functions

No. of cooking functions	1
Traditional cooking functions	



Circulaire

Recipes	No
Cleaning functions	No

Programs / Functions Auxiliary Oven

Funções de cozedura cavidade 2	1
Defrost	No
Vapor Clean	No

Programs / Functions Third Oven

No. of functions third oven	1
Oven light	
Half grill	No
Full grill	

Hob technical features



Total no. of cook zones 4

Front left - Induction - single - 1.50 kW - Booster 2.00 kW - - Ø 18.0 cm

Rear left - Induction - single - 1.50 kW - Booster 2.00 kW - - Ø 18.0 cm

Rear right - Induction - single - 1.50 kW - Booster 2.00 kW - - Ø 18.0 cm

Front right - Induction - single - 1.50 kW - Booster 2.00 kW - - Ø 18.0 cm

Right - Warming zone

Number of Flexible zones 2

Main Oven Technical Features



No. of lights	1	Removable door	Yes
Fan number	1	Full glass inner door	Yes
Net volume of the cavity	61 l	Removable inner door	Yes
Gross volume, 1st cavity	70 l	Total no. of door glasses	3
Cavity material	Ever Clean enamel	No. of thermo-reflective door glasses	1
No. of shelves	4	Safety Thermostat	Yes
Type of shelves	Metal racks	Cooling system	Tangential
Roof Liner	No	Usable cavity space dimensions (HxWxD)	316x460x412 mm
Light type	Halogen	Temperature control	Electro-mechanical
Light Power	40 W	Circular heating element - Power	2000 W
Cooking time setting	Start and Stop	Tilting grill	No
Door opening	Side opening		

Options Main Oven

Timer	Yes	Minimum Temperature	50 °C
End of cooking acoustic alarm	Yes	Maximum temperature	245 °C

Second Oven Technical Features



Fan number	1	Removable inner door	No
Net volume of the second cavity	62 l	No. total door glasses	2
Gross volume, 2nd cavity	69 l	No. thermo-reflective door glasses	1
Cavity material	Ever Clean enamel	Safety Thermostat	Yes
No. of shelves	9	Cooling system	Tangential
Type of shelves	Metal racks	Usable cavity space dimensions (HxWxD)	605x275x370 mm
Roof Liner	No	Temperature control	Electro-mechanical
Door opening	Side opening	Potência da resistência circular	2500 W
Removable door	Yes	Tilting grill	No
Full glass inner door	Yes		

Options Auxiliary Oven

Timer	No	Minimum Temperature	50 °C
End of cooking acoustic alarm	No	Maximum temperature	245 °C

Third Oven Technical Features



Net volume, 3rd cavity	35 l	No. total door glasses	3
Gross volume, 3rd cavity	41 l	No. of thermo-reflective door glasses	1
Cavity material	Ever Clean enamel	Safety Thermostat	Yes
No. of shelves	2	Cooling system	Tangential
Type of shelves	Metal racks	Usable cavity space dimensions (HxWxD)	169x440x443 mm
Roof Liner	No	Temperature control	Electro-mechanical
Door opening	Flap down	Large grill - Power	2700 W
Removable door	Yes	Grill type	Electric
Full glass inner door	Yes	Tilting grill	Yes
Removable inner door	Yes		

Options Third Oven

Timer	No	Minimum Temperature	50 °C
End of cooking acoustic alarm	No	Maximum temperature	260 °C

Accessories included for Main Oven & Hob

40mm deep tray	1
-----------------------	---

Rack com batente
traseiro e lateral 1

Accessories included for Secondary Oven

Oven grid with back
stop 3

Electrical Connection

Plug No
Electrical connection 15200 W
rating
Current 41 A
Voltage 220-240 V
Voltage 2 (V) 380-415 V

Electric cable Installed, Single phase
Type of electric cable Double and Three Phase
Frequency 50/60 Hz
Bloco de terminais 5 polos

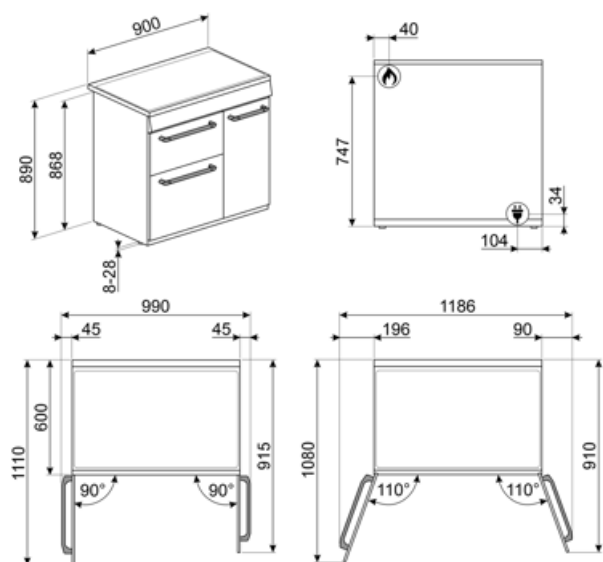

Compatible Accessories

AIRFRY

Air fryer rack AIRFRY . Ideal for recreating traditional frying in the oven, but with fewer calories and less fat. It allows you to cook quickly and simply dishes such as French fries, fried vegetables and fish, ensuring perfect browning and crispiness.



BG6090-1

Placa grelhadora de ferro fundido adequada para fogões Concerto



BN640

Tabuleiro esmaltado, 40mm de profundidade



GRM

Suporte moka para placas a gás



GTT

** Guias telescópicas totalmente extraíveis (1 nível)** Extração: 433 mm
Material: Aço inoxidável AISI 430 polido



BBQ

Double sided plate BBQ. Suitable for recreating succulent and crispy dishes in the oven with the typical taste of grilled cooking. The ribbed side is particularly suitable for meats and cheeses. The smooth side for fish, seafood and vegetables.



BN620-1

Tabuleiro esmaltado, 20mm de profundidade



BNP608T

Bandeja revestida de teflon, 8mm de profundidade, a ser colocada na grade



GTP

** Guias telescópicas parcialmente extraíveis (1 nível)** Extração: 300 mm
Material: Aço inoxidável AISI 430 polido



KIT90N9

Painel anti-salpicos 90 cm, preto, para fogões BU & BM

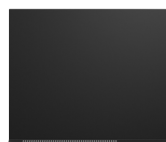

KITH93

Kit extensão de altura (950 mm), adequado para fogões TR93



SCRP

Placas de indução e de cerâmica e raspador teppanyaki



PALPZ

Pá para pizza com alça dobrável largura: 315mm comprimento : 325mm



SFLK1

Bloqueio para crianças



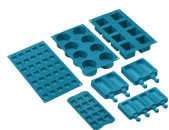

SMOLD

Conjunto de 7 moldes de silicone para sorvetes, gelados, pralinés, cubos de gelo ou para porção de alimentos. Utilizável de -60°C a +230°C



WOKGHU

























Suporte de ferro fundido para WOK



STONE

Pedra refratária retangular Ideal para cozinhar pizzas com os mesmos resultados de um forno típico a lenha. Também pode ser usado para assar pães, focaccias e outras receitas como tortas, flans ou biscoitos
Dimensões:L42 x H1,8 x P37,5 cm.

Symbols glossary

 <p>R: Desempenho de secagem do produto, medido de A++ a D/G, dependendo da família de produtos</p>	 <p>Instalação em coluna: Instalação em coluna</p>
 <p>Sistema de arrefecimento a ar: para garantir temperaturas de superfície seguras.</p>	 <p>...</p>
 <p>Portas de vidros duplos: Número de portas envidraçadas.</p>	 <p>Portas envidraçadas triplas: Número de portas envidraçadas.</p>
 <p>B: Classificação de energia do produto, medida de A+++ a D/G, dependendo da família de produtos.</p>	 <p>Interior esmaltado: O interior em esmalte de todos os fornos Smeg tem um revestimento antiácido especial que ajuda a manter o interior limpo, reduzindo a quantidade de gordura de cozimento aderente a ele.</p>
 <p>Circulaire: A combinação do ventilador e do elemento circular em torno dele dá um método de cozimento de ar quente. Isso oferece muitos benefícios, incluindo nenhum pré-aquecimento se o tempo de cozimento for superior a 20 minutos, nenhuma transferência de sabor ao cozinhar alimentos diferentes ao mesmo tempo, menos energia e tempos de cozimento mais curtos. Bom para todos os tipos de alimentos.</p>	 <p>Elemento de grelha O uso de grelha dá excelentes resultados ao cozinhar carne de porções médias e pequenas, especialmente quando combinada com uma rotisseria (sempre que possível). Também é ideal para cozinhar salsichas e bacon.</p>
 <p>Luz</p>	 <p>Indução: O trabalho destas placas baseia-se no princípio da indução electromagnética. O calor é gerado diretamente na parte inferior da panela durante o seu contato com a placa.</p>
 <p>Toda a porta interna de vidro: Toda a porta interna de vidro, uma única superfície plana que é simples de manter limpa.</p>	 <p>O vidro interior da porta: pode ser removido com alguns movimentos rápidos para limpeza.</p>
 <p>Luzes laterais: Duas luzes laterais opostas aumentam a visibilidade dentro do forno.</p>	 <p>O compartimento do forno tem 2 níveis de cozimento diferentes.</p>
 <p>O compartimento do forno tem 4 níveis de cozimento diferentes.</p>	 <p>O compartimento do forno tem 9 níveis de cozimento diferentes.</p>
 <p>Comando eletrônico. Permite manter a temperatura no interior do forno com a precisão de 2-3 ° C. Isso permite cozinhar refeições que são muito sensíveis a mudanças de temperatura, como por ex. bolos, suflês, pudins.</p>	 <p>Grelha basculante: a grelha basculante pode ser facilmente desengatada para mover o elemento de aquecimento e limpar o tejadilho do aparelho em um simples passo.</p>
 <p>TWIN_ZONE_72dpi</p>	 <p>A capacidade indica a quantidade de espaço útil no compartimento do forno em litros.</p>
 <p>A capacidade indica a quantidade de espaço útil no compartimento do forno em litros.</p>	 <p>A capacidade indica a quantidade de espaço útil no compartimento do forno em litros.</p>



Mantenha a função quente: Mantenha a função quente mantém o alimento cozido aquecido. Neste modo, a zona de aquecimento funciona a uma capacidade mínima de 120 minutos e

Benefit (TT)

Induction hob

Induction offers fast cooking and precise temperature control

Through the use of suitable cookware, induction is easy to use and maintain, safe and responsive.

Ever Clean Enamel

Easy oven cleaning thanks to special pyrolytic enamel

Touch control

Easy and intuitive timer setting with a single touch

True-convection

The best cooking performances guaranteed by ventilated circular flow

Multiple fans and heating elements guarantee the perfect aerodynamic heat flow, allowing homogeneous and quicker cooking inside the cavity.

Multilevel cooking

Several cooking levels allow maximum flexibility of use

Multilevel halogen light

Internal halogen lighting on different levels guarantees excellent visibility

Removable inner glass

Internal door glasses are easily removable for complete cleaning

Tangential cooling

New cooling system with tangential fan and airflow from the door to the splashback

Isothermic Cavity

The best cooking performance at the highest energy efficiency

Adjustable height

Cooker top flushed with the working area thanks to adjustable feet

Cold door

During any function, the external door glass is cold, avoiding any risk of burns

AirFry (AIRFRY optional accessory)

Lighter and tastier food thanks to airfry basket (optional accessory)

BBQ (optional accessory)

Barbeque cooking directly in the oven with the double-sided grill (BBQ optional accessory)

Pizza stone (optional accessory)

Baking with refractory stone for soft and crispy pizza and yeast products (STONE optional accessory)

Single turbine

The oven has a fan equipped with a circular heating element allowing cooking with rotating heat