

# D4B-1

Product Family	Dishwashers
Width	45 cm
Commercial height	85 cm
Installation	Free-standing
Motor	Single phase
EAN code	8017709184179

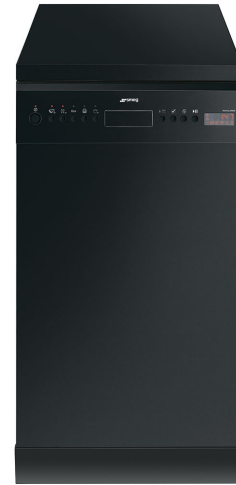

## Programmes



No. of programmes	10	Auto sensor 45-65	Yes
Washing temperatures	38, 45, 50, 65, 70 °C	ECO Quick	Yes
Soak	Yes	Delicate and Quick	Yes
Rapid 27'	Yes	Mix Express	Yes
Glass	Yes	Strong and fast	Yes
ECO	Yes	Super	Yes

## Options



Delay timer option	Up to 24 hours, with automatic soak	Quick Time option	Yes
1/2 load FlexiZone option (varied distribution)	Yes	Sanitizing option Hyclean	Yes
Options for tabs FlexiTabs	Yes		

## Baskets



Basket colour	Grey	Largest loadable dish in upper basket	23,5 cm
Basket components colour	Grey	Lower Basket	With 4 foldable racks

<b>Handle</b>	In plastic only on lower basket	<b>Lower basket with anti-drip inserts</b>	Yes
<b>Upper Basket</b>	With central fixed racks	<b>Largest loadable dish in lower basket</b>	30,0 cm
<b>Height adjustment of the upper basket</b>	On three levels	<b>Cutlery basket</b>	10 place settings

## Technical Features



<b>Width (mm)</b>	448 mm	<b>Turbidity sensor</b>	Yes
<b>Depth (mm)</b>	600 mm	<b>Aquatest</b>	
<b>Display type</b>	3 digit	<b>Flood protection system</b>	Total Acquastop
<b>Product Height (mm)</b>	848 mm	<b>Water supply</b>	Single; cold/hot water max. 60°C - energysave with hot water up to 35%
<b>Controls</b>	Electronic	<b>Max water hardness</b>	100°FH;58°dH
<b>Display</b>	Delayed start, Programme time indicator, Time to end indication	<b>Drying system</b>	Natural condenser drying
<b>Programme graphics</b>	Symbols	<b>Tank material</b>	Stainless steel
<b>On/off indicator</b>	Yes	<b>Filter</b>	Stainless steel
<b>Salt light indicator</b>	Light	<b>Concealed heating element</b>	Yes
<b>Rinse aid indicator</b>	Light	<b>Hinges</b>	Self balancing with fixed hinges
<b>Progress indicator</b>	Yes	<b>Adjustable feet</b>	Just for levelling
<b>End of cycle indicator</b>	Acoustic signal	<b>Insulation level</b>	Medium
<b>Washing system</b>	SwingWash	<b>Back cover</b>	Yes
<b>Third spray arm</b>	Single	<b>Depth of dishwasher with open door (mm)</b>	1173
<b>Water softener</b>	With electronic setting	<b>Removable top</b>	Yes, with optional KIT
		<b>Top cover</b>	In plastic

## Performance / Energy Label

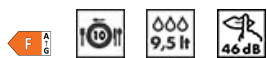

<b>Energy Efficiency Class (Washing cycle)</b>	F	<b>Airborne acoustical noise emissions (spinning phase)</b>	46 dB(A) re 1 pW
<b>Energy consumption [per 100 cycles, based on the eco programme]</b>	83 KWh	<b>Airborne acoustical noise emission class</b>	C
<b>Rated capacity (ps)</b>	10	<b>Energy efficiency Index (EEI) (Washing cycle)</b>	61,5
<b>Water consumption [per cycle]</b>	9,5 litres		

## Electrical Connection

<b>Plug</b>	(G) UK e Singapore	<b>Frequency (Hz)</b>	50 Hz
<b>Connected power</b>	1800 W	<b>Type of connection</b>	Single-phase
<b>Current</b>	13 A	<b>Power supply cable length</b>	140 cm
<b>Voltage</b>	220-240 V		

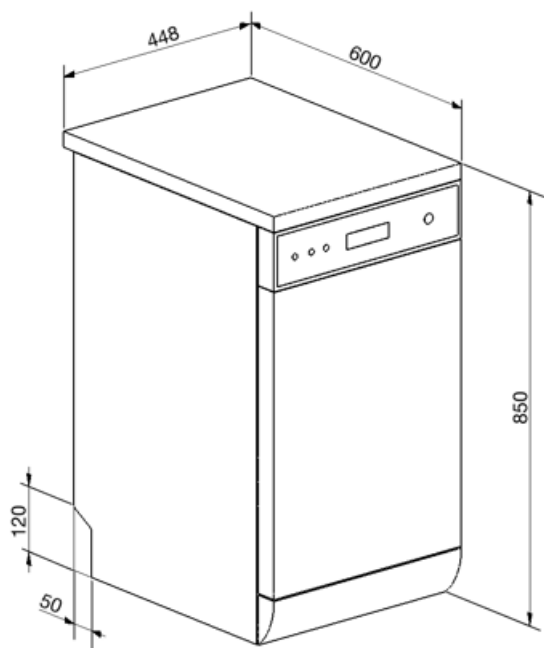

---

## Not included accessories





















---

**KITPLV2**

Kit extension for dishwasher and washing machine: length mt. 2



## Symbols glossary

	<p><b>Aquatest</b> measures the clarity of the water during an auto program, and automatically ensures the minimum consumption of water and energy.</p>		<p><b>Anti-drip:</b> Some models of dishwashers are equipped with special polymer nozzles anti-drip, that improve the process of drying.</p>
	<p><b>A+:</b> Energy efficiency class A+ helps to save up to 10% energy compared to class A. Maximum performance with minimum consumption is guaranteed.</p>		<p><b>Delay Timer:</b> The delay timer can postpone the start of the program by up to 24 hours.</p>
	<p><b>Flexitabs:</b> Flexitabs adjusts the wash cycle to give the best possible results regardless of the type of detergent used.</p>		<p><b>FlexiZone:</b> The ½ load flexizone allows you to wash a reduced load saving energy, water and time and there are no restrictions on where the items are placed.</p>
	<p><b>Hyclean:</b> When the HYCLEAN option is selected, the dishwasher performs a final 10 minute rinse at a high temperature of 70°C, eliminating virtually all bacteria to achieve the highest possible standards of cleanliness. The Hyclean option can be selected with almost all cycles at temperatures above 50°C.</p>		<p><b>Noise Level:</b> Excellent insulation and special devices keep noise to a minimum.</p>
	<p><b>Auto 45°- 65°:</b> The auto programme regulates the length of a cycle depending on the need for a pre-wash and the number of rinses required.</p>		<p><b>Delicate Quick:</b> Program Delicate Quick is suitable for quick washing of delicate dishes.</p>
	<p><b>Eco:</b> Eco, this economic wash programme uses a low amount of water and energy in order to provide the most environmentally friendly cleaning option.</p>		<p><b>Eco:</b> Eco, this economic wash programme uses a low amount of water and energy in order to provide the most environmentally friendly cleaning option.</p>
	<p><b>Soak programme:</b> The soak programme provides a rinse to prevent dirt from drying.</p>		<p><b>PRG_STRONG_72dpi</b></p>
	<p><b>Strong&amp;Fast:</b> This special programme takes less than 1 hour to eliminate the most stubborn dirt and dried on residues.</p>		<p>The symbols show the number of plate settings of the dishwasher.</p>
	<p><b>Swing Wash System:</b> The Swing Wash system ensures optimum water distribution throughout 45cm dishwasher tanks to deliver excellent wash results.</p>		<p><b>Total Acquastop:</b> In addition to the partial Acquastop protection present in all Smeg dishwashers, some models have an electronic device fitted to the water intake hose, which monitors water levels in the machine, detects leaks in the hose and switches off the water supply immediately when necessary.</p>
	<p><b>System WaterSave</b> ensures the best washing results with minimal water consumption depending on the model of dishwasher.</p>		<p><b>Energy efficiency class F</b></p>