

D4SS-1

Product Family	Dishwashers
Commercial width	45 cm
Commercial height	85 cm
Installation	Free-standing
Motor	Single phase
EAN code	8017709184193



Programs



N. of programmes	10	Auto sensor 45-65	Yes
Washing temperatures	38, 45, 50, 65, 70 °C	ECO Quick	Yes
Soak	Yes	Delicate and Quick	Yes
Rapid 27'	Yes	Mix Express	Yes
Glass	Yes	Strong and fast	Yes
ECO	Yes	Super	Yes

Options



Delay timer option	Up to 24 hours	Quick Time option	Yes
1/2 load FlexiZone option	Yes	Sanitizing option Hyclean	Yes
Options for tabs FlexiTabs	Yes		

Baskets



Basket colour	Grey	Largest loadable dish in upper basket	23,5 cm
Basket components colour	Grey	Lower Basket	With 4 foldable racks
Handle	In plastic only on lower basket	Lower basket with anti-drip inserts	Yes

Upper Basket	With central fixed racks	Largest loadable dish in lower basket	30,0 cm
Height adjustment of the upper basket	On three levels (5 cm)	Cutlery basket	10 place settings

Technical Features



Width (mm)	448 mm	Turbidity sensor	Yes
Depth (mm)	600 mm	Aquatest	
Display type	LED display (3 digit)	Flood protection system	Total Acquastop
Product Height (mm)	848 mm	Water supply	Single; cold/hot water max. 60°C - energysave with hot water up to 35%
Controls	Electronic	Max water hardness	100°FH;58°dH
Display	Delayed start, Programme time indicator, Time to end indication	Drying system	Natural condenser drying
Programme graphics	Symbols	Tube material	Stainless steel
On/off indicator	Yes	Filter	Stainless steel
Salt light indicator	Light	Concealed heating element	Yes
Rinse aid indicator	Light	Hinges	Self balancing with fixed hinges
Progress indicator	Yes	Adjustable feet	Just for levelling
End of cycle indicator	Acoustic signal	Insulation level	Medium
Washing system	SwingWash	Back cover	Yes
Third spray arm	Single	Depth of dishwasher with open door (mm)	1173 mm
Water softener	With electronic setting	Removable top	Yes, with optional KIT
		Top cover	In plastic

Performance / Energy Label - Reg. 2019

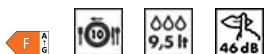

Energy Efficiency Class	F	Airborne acoustical noise emissions	46 dB(A) re 1 pW
Energy consumption [per 100 cycles, based on the eco programme]	83 kWh	Airborne acoustical noise emission class	C
Rated capacity (ps)	10	Energy efficiency Index (EEI)	61,5
Water consumption [per cycle]	9,5 litres		

Electrical Connection

Connected power	1800 W	Frequency (Hz)	50 Hz
Current	13 A	Type of connection	Single-phase
Voltage	220-240 V	Power supply cable length	140 cm

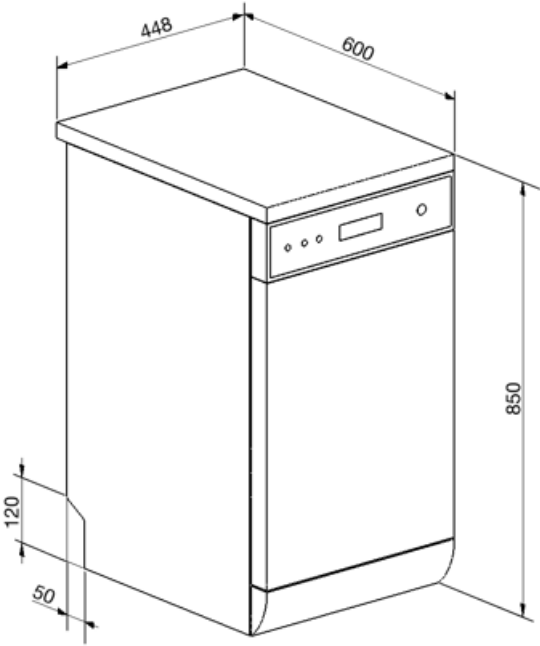





















Compatible Accessories

KITPLV2

Kit extension for dishwasher and washing machine: lenght mt. 2



Symbols glossary

 <p>A+: Energy efficiency class A+ helps to save up to 10% energy compared to class A. Maximum performance with minimum consumption is guaranteed.</p>	 <p>The Aquatest sensor is an electronic sensor that measures the degree of water transparency at the end of the initial soaking phase. Based on the values measured, the sensor sets the most suitable programme, thus obtaining the best washing results with the minimum amount of water.</p>
 <p>To improve the drying of dishes without leaving stains.</p>	 <p>Delay Timer: Option to postpone the start of the desired programme by up to 24 hours in order to programme the dishwasher to run at the desired time.</p>
 <p>Fingerprint proof stainless steel: Fingerprint proof stainless steel keeps stainless steel looking as good as new.</p>	 <p>Ideal for multi-function detergents, this option allows washing to be optimised, with full benefits from the combined-action tablets. When this option is activated, any salt and rinse aid is used.</p>
 <p>FlexiZone: The ½ load flexizone allows you to wash a reduced load saving energy, water and time and there are no restrictions on where the items are placed.</p>	 <p>Hyclean: When the HYCLEAN option is selected, the dishwasher performs a final 10 minute rinse at a high temperature of 70°C, eliminating virtually all bacteria to achieve the highest possible standards of cleanliness. The Hyclean option can be selected with almost all cycles at temperatures above 50°C.</p>
 <p>Noise Level: Excellent insulation and special devices keep noise to a minimum.</p>	 <p>Auto 45°- 65°: The auto programme regulates the length of a cycle depending on the need for a pre-wash and the number of rinses required.</p>
 <p>Delicate Quick: Program Delicate Quick is suitable for quick washing of delicate dishes.</p>	 <p>Eco: Eco, this economic wash programme uses a low amount of water and energy in order to provide the most environmentally friendly cleaning option.</p>
 <p>Eco: Eco, this economic wash programme uses a low amount of water and energy in order to provide the most environmentally friendly cleaning option.</p>	 <p>Soak programme: The soak programme provides a rinse to prevent dirt from drying.</p>
 <p>PRG_STRONG_72dpi</p>	 <p>Strong&Fast: This special programme takes less than 1 hour to eliminate the most stubborn dirt and dried on residues.</p>
 <p>10 place settings: Number of place settings.</p>	 <p>Swing Wash System: The Swing Wash system ensures optimum water distribution throughout 45cm dishwasher tanks to deliver excellent wash results.</p>
 <p>Total Acquastop: In addition to the partial Acquastop protection present in all Smeg dishwashers, some models have an electronic device fitted to the water intake hose, which monitors water levels in the machine, detects leaks in the hose and switches off the water supply immediately when necessary.</p>	 <p>System WaterSave ensures the best washing results with minimal water consumption depending on the model of dishwasher.</p>

