

# DAU6335DX4



<b>Product Family</b>	Dishwashers
<b>Commercial width</b>	60 cm
<b>Commercial height</b>	82 cm
<b>Kitchen panel</b>	Not supplied
<b>N° baskets</b>	3, FlexiDuo
<b>Motor</b>	Inverter 2.0
<b>EAN code</b>	8017709362973



## Programs

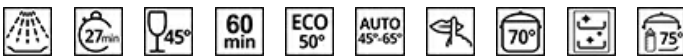

<b>N. of programmes</b>	10+1	<b>Auto sensor 45-65</b>	Yes
<b>Washing temperatures</b>	38, 45, 50, 55, 65, 70, 75 °C	<b>Quiet (~2 dB)</b>	Yes
<b>Soak</b>	Yes	<b>Intense</b>	Yes
<b>Express 27'</b>	Yes	<b>Self clean</b>	Yes
<b>Crystal</b>	Yes	<b>Hygiene 99,9%</b>	Yes
<b>Full express - 60 minutes</b>	Yes	<b>1/2 load</b>	
<b>ECO</b>	Yes		

## Options



<b>Dry Assist option</b>		<b>Options for tabs</b>	
<b>Dry Assist+ option</b>	Yes	<b>FlexiTabs</b>	
<b>Delay timer option</b>	Up to 24 hours	<b>Special programs option</b>	Yes

## Baskets



<b>Basket colour</b>	Grey	<b>Lower Basket</b>	With fully foldable inserts
<b>Basket components colour</b>	Grey	<b>Lower basket accessories</b>	MultiLoad, ProFlex Holder, WinePro
		<b>Lower basket with anti-drip inserts</b>	Yes

<b>Handle</b>	In plastic with stainless steel insert on upper and lower basket	<b>Largest loadable dish in lower basket</b>	30,0 cm
<b>Upper Basket</b>	With 3 foldable racks	<b>Colour Inner Components</b>	Sage Leaf
<b>Height adjustment of the upper basket</b>	On three levels	<b>Cutlery basket</b>	13 place settings sliding
<b>Sliding Guides Extra Glide</b>	Yes		
<b>Largest loadable dish in upper basket</b>	19,0 cm		

## Technical Features



<b>Width (mm)</b>	598 mm	<b>Water supply</b>	Single; cold/hot water max. 60°C - energysave with hot water up to 35%
<b>Depth (mm)</b>	570 mm	<b>Max water hardness</b>	100°FH;58°dH
<b>Display type</b>	LED display (3 digit)	<b>Drying system</b>	Natural condenser drying, with Dry Assist + automatic door opening system at the end of the cycle
<b>Product Height (mm)</b>	818 mm	<b>Steam protection</b>	In plastic
<b>Controls</b>	Electronic	<b>Child safety system (door lock)</b>	Yes
<b>Display</b>	Delayed start, Programme time indicator, Time to end indication	<b>Tub material</b>	Stainless steel
<b>Programme graphics</b>	Symbols	<b>Filter</b>	Stainless steel
<b>On/off indicator</b>	Yes	<b>Concealed heating element</b>	Yes
<b>Salt light indicator</b>	Light	<b>Hinges</b>	Self balancing with fixed hinges
<b>Rinse aid indicator</b>	Light	<b>Min. and max plinth height</b>	100 - 170 mm
<b>Progress indicator</b>	Yes	<b>Adjustable feet</b>	7cm, from 820 to 890 mm
<b>End of cycle indicator</b>	On display, with acoustic signal	<b>Additional gaskets</b>	Yes, with stainless steel plate
<b>Washing system</b>	Planetarium	<b>Back cover</b>	Yes
<b>Third spray arm</b>	Single	<b>Depth of dishwasher with open door (mm)</b>	1146 mm
<b>Water softener</b>	With electronic setting	<b>Back feet adjustable from front</b>	Yes
<b>Turbidity sensor</b>	Yes	<b>Adjustable plinth</b>	By height and depth
<b>Aquatest</b>		<b>Top cover</b>	In plastic
<b>Flood protection system</b>	Total Acquastop		

## Electrical Connection

<b>Connected power</b>	1800 W	<b>Type of connection</b>	Single-phase
<b>Current</b>	10 A	<b>Power supply cable length</b>	140 cm
<b>Voltage</b>	220-240 V	<b>Plug</b>	(I) Australia
<b>Frequency (Hz)</b>	50 Hz		

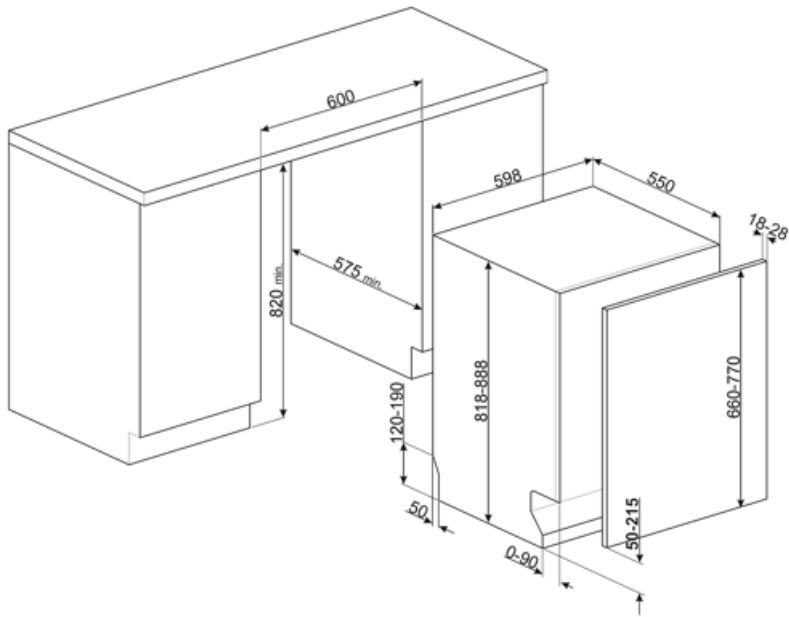

---

## Compatible Accessories

---



### KITGH

Kit glass holder. It has to be fitted on the first basket but only if there are foldable racks



### KITPL60FABN

Toekick Kit in Black colour with adjustable height. Can be fitted over all the fully integrated and underbench models with Fixed Fulcrum. Can be installed also on the models with variable fulcrum or flexifit hinges.



### KITPLV2

Kit extension for dishwasher and washing machine: lenght mt. 2



### KITPL60FABB





















Toekick Kit in White colour with adjustable height. Can be fitted over all the fully integrated and underbench models with Fixed Fulcrum. Can be installed also on the models with variable fulcrum or flexifit hinges.



### KITPL60FABX

Toekick Kit in Stainless Steel with adjustable height. Can be fitted over all the fully integrated and underbench models with Fixed Fulcrum. Can be installed also on the models with variable fulcrum or flexifit hinges.

## Symbols glossary

 <p>Aquatest measures the clarity of the water during an auto program, and automatically ensures the minimum consumption of water and energy.</p>	 <p>Anti-drip: Some models of dishwashers are equipped with special polymer nozzles anti-drip, that improve the process of drying.</p>
 <p>Child lock: some models are fitted with a device to lock the programme/cycle so it cannot be accidentally changed.</p>	 <p>COMM_HEIGHT_82_72dpi</p>
 <p>Delay Timer: The delay timer can postpone the start of the program by up to 24 hours.</p>	 <p>The Dry Assist + option, in addition to saving energy, ensures perfect drying of the dishes by opening the door automatically at the end of the wash c</p>
 <p>FlexiDuo: The FlexiDuo 3rd cutlery basket allows you to arrange cutlery or small cups, ladles, or bulky utensils however you like: it consists of two separate and moveable modules.</p>	 <p>The new ExtraGlide guide system, available on top of the range models, makes the second basket even smoother and softer. In fact, it facilitates the extraction of the introduction, even at full load and, for the greater excursion, the insertion of crockery is also facilitated in the rear part.</p>
 <p>The work aimed at continuous improvement has allowed the creation of the second generation of the Inverter motor 2.0, characterised by greater efficiency and durability over time, which allows very high performance and a lower energy consumption and noise level.</p>	 <p>Noise Level: Excellent insulation and special devices keep noise to a minimum.</p>
 <p>PLANETARIUM_WASHING_SYSTEM_72dpi</p>	 <p>Auto 45°- 65°: The auto programme regulates the length of a cycle depending on the need for a pre-wash and the number of rinses required.</p>
 <p>Crystals: The Crystals programme is dedicated to delicate dishes such as glasses and china.</p>	 <p>Eco: Eco, this economic wash programme uses a low amount of water and energy in order to provide the most environmentally friendly cleaning option.</p>
 <p>Quick wash cycle for normally soiled mixed loads such as dishes and pans, even with dried-on residues. Dishes are washed and dried in 60 minutes.</p>	 <p>Dishwasher cleaning cycle. The cycle should be started with the machine empty, without dishes. It is recommended to run the program every 2-3 months, using special dishwasher detergents.</p>
 <p>Soak programme: The soak programme provides a rinse to prevent dirt from drying.</p>	 <p>Rapid 27 Mins: The rapid 27 mins quick program takes just 27 minutes to wash a load.</p>
 <p>Ultraclean: The Ultraclean option performs a final rinse at a high temperature of 70°C eliminating virtually all bacteria.</p>	 <p>The symbols show the number of plate settings of the dishwasher.</p>



**Total Acquastop:** In addition to the partial Acquastop protection present in all Smeg dishwashers, some models have an electronic device fitted to the water intake hose, which monitors water levels in the machine, detects leaks in the hose and switches off the water supply immediately when necessary.



Allows you to enable additional programs when selected together with any wash cycle.



**SILENT:** Wash cycle suitable for normally soiled dishes, even with dried-on residues. Ensures maximum noise reduction and is therefore ideal if you wish to run it during the night.



**HYGIENE 99.9%** High-temperature washing programme. The 75° rinse guarantees the removal of 99.9% of germs and bacteria, making it ideal for sanitising