

# DF262DB



Product Family	Dishwashers
Commercial width	60 cm
Commercial height	85 cm
Installation	Free-standing
N° baskets	2
Motor	Inverter 2.0
EAN code	8017709335960



## Programs



N. of programmes	8	ECO	Yes
Washing temperatures	50, 60, 65, 70 °C	Mix	Yes
Soak	Yes	Self clean	Yes
Full express - 60 minutes	Yes	Intense 60°	Yes
Express 50°	Yes	Auto 50°-60°	Yes

## Options



Delay timer option	Up to 24 hours	Crystal option	Yes
Extreme option	Yes	Sterilise option	Yes

## Baskets

Basket colour	Grey	Lower Basket	With fixed racks
Basket components colour	Grey	Largest loadable dish in lower basket	31.0 cm
Upper Basket	With central fixed racks	Colour Inner Components	Grey
Height adjustment of the upper basket	On two levels (4 cm)	Cutlery basket	Yes
Largest loadable dish in upper basket	20,0 cm		

## Technical Features



<b>Width (mm)</b>	598 mm	<b>Water softener</b>	With electronic setting
<b>Depth (mm)</b>	600 mm	<b>Turbidity sensor Aquatest</b>	Yes
<b>Display type</b>	LED display	<b>Water supply</b>	Single; cold/hot water max. 60°C - energysave with hot water up to 35%
<b>Product Height (mm)</b>	848 mm	<b>Max water hardness</b>	90°FH; 50°dH
<b>Controls</b>	Electronic	<b>Drying system</b>	Natural condenser drying, with Dry Assist automatic door opening system at the end of the cycle
<b>Display</b>	Delayed start, Programme time indicator, Time to end indication	<b>Tube material</b>	Stainless steel
<b>Programme graphics</b>	Symbols	<b>Filter</b>	Stainless steel
<b>Salt light indicator</b>	Light	<b>Concealed heating element</b>	Yes
<b>Rinse aid indicator</b>	Light	<b>Hinges</b>	Self balancing with fixed hinges
<b>Progress indicator</b>	Yes	<b>Adjustable feet</b>	Just for levelling
<b>End of cycle indicator</b>	On display, with acoustic signal	<b>Depth of dishwasher with open door (mm)</b>	1146 mm
<b>Washing system</b>	Standard	<b>Removable top</b>	Yes
<b>Third spray arm</b>	Single	<b>Top cover</b>	In plastic

## Performance / Energy Label - Reg. 2019



<b>Energy Efficiency Class</b>	D	<b>Programme duration</b>	4:00 h:min
<b>Energy consumption [per 100 cycles, based on the eco programme]</b>	94 kWh	<b>Airborne acoustical noise emissions</b>	46 dB(A) re 1 pW
<b>Rated capacity (ps)</b>	13	<b>Airborne acoustical noise emission class</b>	C
<b>Water consumption [per cycle]</b>	9.9 litres	<b>Energy efficiency Index (EEI)</b>	55.9

## Electrical Connection

<b>Connected power</b>	1950 W	<b>Type of connection</b>	Single-phase
<b>Current</b>	10 A	<b>Power supply cable length</b>	150 cm
<b>Voltage</b>	220-240 V	<b>Plug</b>	(G) UK e Singapore
<b>Frequency (Hz)</b>	50 Hz		

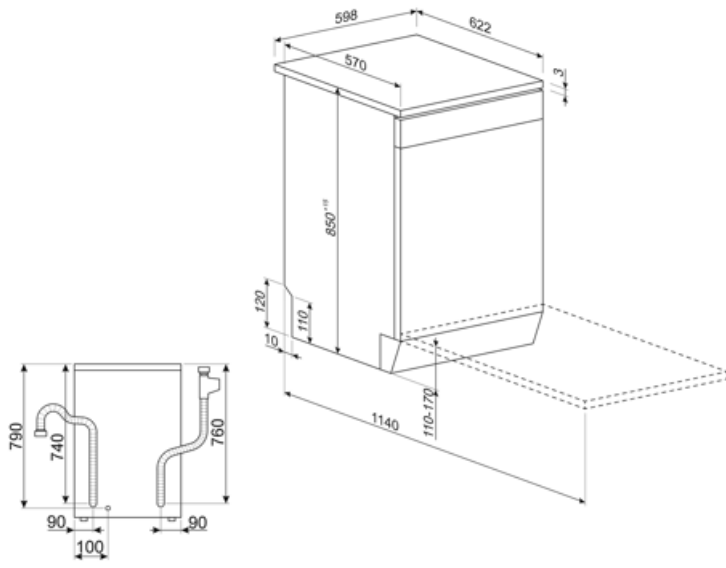

---

## Compatible Accessories

---

**KITINC**

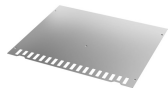



















**KITPLV2**



Kit extension for dishwasher and washing machine: lenght mt. 2

## Symbols glossary

	<p>The Aquatest sensor is an electronic sensor that measures the degree of water transparency at the end of the initial soaking phase. Based on the values measured, the sensor sets the most suitable programme, thus obtaining the best washing results with the minimum amount of water.</p>		<p>Energy efficiency class D</p>
	<p>Delay Timer: Option to postpone the start of the desired programme by up to 24 hours in order to programme the dishwasher to run at the desired time.</p>		<p>This option provides special care for a delicate load. It prevents rapid changes in the wash temperature of the selected programme and reduces it to 4</p>
	<p>Noise Level: Excellent insulation and special devices keep noise to a minimum.</p>		<p>Eco: Eco, this economic wash programme uses a low amount of water and energy in order to provide the most environmentally friendly cleaning option.</p>
	<p>Mix: The Mix programme is suitable for mixed crockery and everyday pots and pans, without any particular incrustation.</p>		<p>A quick programme suitable for washing a load with fresh and light soil.</p>
	<p>Soak programme: The soak programme provides a rinse to prevent dirt from drying.</p>		<p>13 place settings: Number of place settings.</p>
	<p>Quick wash cycle for normally soiled mixed loads such as dishes and pans, even with dried-on residues. Dishes are washed and dried in 60 minutes.</p>		<p>Dishwasher cleaning cycle. The cycle should be started with the machine empty, without dishes. It is recommended to run the program every 2-3 months, using special dishwasher detergents.</p>
	<p>Wash cycle for normally soiled mixed loads such as dishes and pans, even with dried-on residues. When this program is selected, the dishwasher recognises the type of dirt and automatically adjusts the washing parameters as appropriate.</p>		<p>Programme suitable for washing and drying heavily soiled items with encrusted residues.</p>
	<p>Option which improves the washing results of the selected programme. It increases the wash temperature and duration.</p>		<p>Option which provides better cleaning results by keeping the temperature between 65 and 70°C for at least 10 minutes during the last rinsing phase.</p>
	<p>System WaterSave ensures the best washing results with minimal water consumption depending on the model of dishwasher.</p>		<p>The work aimed at continuous improvement has allowed the creation of the second generation of the Inverter motor 2.0, characterised by greater efficiency and durability over time, which allows very high performance and a lower energy consumption and noise level.</p>