

DF352CS

Product Family	Dishwashers
Width	60 cm
Commercial height	85 cm
Installation	Free-standing
N° baskets	3, Flexi
EAN code	8017709307790



Programmes



No. of programmes	10	ECO	Yes
Washing temperatures	38, 45, 50, 65, 70, 75 °C	Mix	Yes
Soak	Yes	Quiet (-2 dB)	Yes
Express 27'	Yes	Intense	Yes
Crystal	Yes	Hygiene 99,9%	Yes
Full express - 60 minutes	Yes	Daily 1/2 load	Yes

Options



Delay timer option	3-6-9 hours, with automatic soak	Special programs option	Yes
--------------------	----------------------------------	-------------------------	-----

Baskets



Basket colour	Grey	Largest loadable dish in upper basket	19,0 cm
Basket components colour	Grey	Lower Basket	With 2 foldable racks
Handle	In plastic on upper and lower basket	Lower basket with anti-drip inserts	Yes
Upper Basket	With 1 foldable rack	Largest loadable dish in lower basket	30,0 cm
Glass holder	Yes		

Height adjustment of the upper basket	On three levels	Colour Inner Components	Blue
---------------------------------------	-----------------	-------------------------	------

Technical Features



Width (mm)	598 mm
Depth (mm)	600 mm
Product Height (mm)	848 mm
Controls	Electronic
Programme graphics	Symbols
On/off indicator	Yes
Salt light indicator	Light
Rinse aid indicator	Light
End of cycle indicator	Led on display, with acoustic signal
Washing system	Orbital
Third spray arm	Single
Water softener	With electronic setting
Flood protection system	Single Acquastop

Water supply	Single; cold/hot water max. 60°C - energysave with hot water up to 35%
Max water hardness	100°FH;58°dH
Drying system	Natural condenser drying, with Dry Assist + automatic door opening system at the end of the cycle
Tank material	Stainless steel
Filter	Stainless steel
Concealed heating element	Yes
Hinges	Self balancing with fixed hinges
Adjustable feet	Just for levelling
Back cover	Yes, with covered counterweight
Depth of dishwasher with open door (mm)	1168
Removable top cover	Yes, with optional KIT In plastic

Performance / Energy Label NEW



Energy Efficiency Class (Washing cycle)	C	Programme duration	4:25 h:min
Energy consumption [per 100 cycles, based on the eco programme]	73 KWh	Airborne acoustical noise emissions (spinning phase)	45 dB(A) re 1 pW
Rated capacity (ps)	13	Airborne acoustical noise emission class	C
Water consumption [per cycle]	9,0 litres	Energy efficiency Index (EEI) (Washing cycle)	43,8

Electrical Connection

Plug	(G) UK e Singapore	Frequency (Hz)	50 Hz
Connected power	1800 W	Type of connection	Single-phase
Current	13 A	Power supply cable length	140 cm
Voltage	220-240 V		

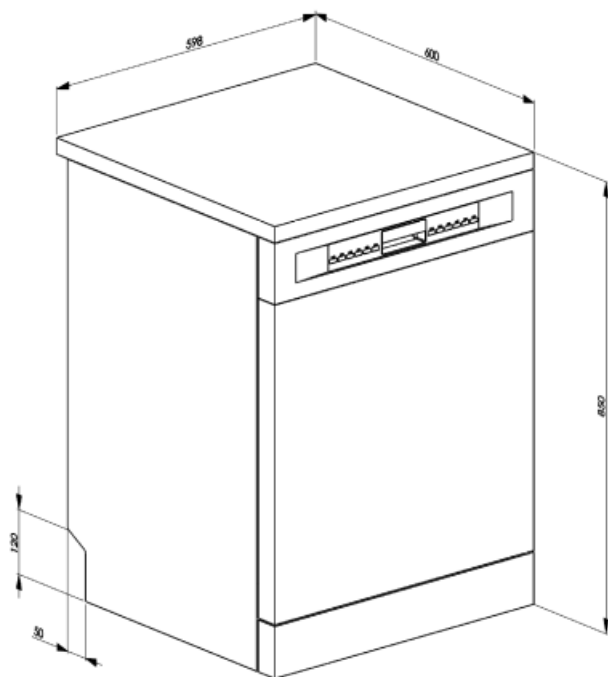

Not included accessories

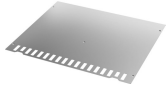

KITINC

a steel bar fitted on the top will block the dishwasher at the top.

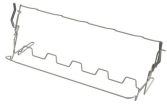

KITGH

Kit glass holder. It has to be fitted on the first basket but only if there are foldable racks



KITPLV2

Kit extension for dishwasher and washing machine: length mt. 2



















Alternative products



DF352CW

Colour: White

Symbols glossary

	Acquastop: Some Smeg dishwashers are equipped with a simple Acquastop: float sensor in the bottom which is necessary to prevent an accidental leakage of water inside the appliance.		Anti-drip: Some models of dishwashers are equipped with special polymer nozzles anti-drip, that improve the process of drying.
	Delay Timer: The delay timer can postpone the start of the program by up to 24 hours.		Noise Level: Excellent insulation and special devices keep noise to a minimum.
	Orbital wash system distributes water evenly throughout the 60cm dishwasher cavity, directing water with precision to ensure an excellent wash.		Crystals: The Crystals programme is dedicated to delicate dishes such as glasses and china.
	1/2 load: This program is designed for washing dishes not heavily soiled with partial load of the dishwasher.		Eco: Eco, this economic wash programme uses a low amount of water and energy in order to provide the most environmentally friendly cleaning option.
	Normal programme: The normal programme is suitable for normal degrees of dirt for everyday use.		Soak programme: The soak programme provides a rinse to prevent dirt from drying.
	Rapid 27 Mins: The rapid 27 mins quick program takes just 27 minutes to wash a load.		Ultraclean: The Ultraclean option performs a final rinse at a high temperature of 70°C eliminating virtually all bacteria.
	The symbols show the number of plate settings of the dishwasher.		System WaterSave ensures the best washing results with minimal water consumption depending on the model of dishwasher.
	...		...
	...		Energy efficiency class C
	HYGIENE 99.9% High-temperature washing programme. The 75° rinse guarantees the removal of 99.9% of germs and bacteria, making it ideal for sanitising		