

# DF613PW



<b>Product Family</b>	Dishwashers
<b>Commercial width</b>	60 cm
<b>Commercial height</b>	85 cm
<b>Installation</b>	Free-standing
<b>N° baskets</b>	3, FlexiDuo
<b>Motor</b>	Single phase
<b>EAN code</b>	8017709226626



## Programs



<b>N. of programmes</b>	5+5 quick programmes	<b>Auto sensor 45-65</b>	Yes
<b>Washing temperatures</b>	38, 45, 50, 65, 70 °C	<b>ECO Quick</b>	Yes
<b>Soak</b>	Yes	<b>Delicate and Quick</b>	Yes
<b>Rapid 27'</b>	Yes	<b>Normal Quick</b>	Yes
<b>Glass</b>	Yes	<b>Super</b>	Yes
<b>ECO</b>	Yes	<b>Super Quick</b>	Yes

## Options



<b>Delay timer option</b>	Up to 24 hours	<b>Quick Time option</b>	Yes
<b>1/2 load FlexiZone option</b>	Yes	<b>Sanitizing option Hyclean</b>	Yes
<b>Options for tabs FlexiTabs</b>	Yes		

## Baskets



<b>Basket colour</b>	Grey	<b>Largest loadable dish in upper basket</b>	23,5 cm
<b>Basket components colour</b>	Grey	<b>Lower Basket</b>	With 4 foldable racks
<b>Handle</b>	In plastic on upper and lower basket	<b>Lower basket with anti-drip inserts</b>	Yes

<b>Upper Basket</b>	With central fixed racks	<b>Largest loadable dish in lower basket</b>	30,0 cm
<b>Height adjustment of the upper basket</b>	On three levels (5 cm)	<b>Cutlery basket</b>	13 place settings sliding
<b>Upper basket with EasyGlide System</b>	Yes		

## Technical Features



<b>Width (mm)</b>	598 mm	<b>Turbidity sensor</b>	Yes
<b>Depth (mm)</b>	600 mm	<b>Aquatest</b>	
<b>Display type</b>	LED (external)	<b>Flood protection system</b>	Total Acquastop
<b>Product Height (mm)</b>	848 mm	<b>Water supply</b>	Single; cold/hot water max. 60°C - energysave with hot water up to 35%
<b>Controls</b>	Electronic	<b>Max water hardness</b>	100°FH;58°dH
<b>Display</b>	Delayed start, Programme time indicator, Time to end indication	<b>Drying system</b>	Natural condenser drying
<b>Programme graphics</b>	Symbols and printed key	<b>Tube material</b>	Stainless steel
<b>On/off indicator</b>	Yes	<b>Filter</b>	Stainless steel
<b>Salt light indicator</b>	Light	<b>Concealed heating element</b>	Yes
<b>Rinse aid indicator</b>	Light	<b>Hinges</b>	Self balancing with fixed hinges
<b>Progress indicator</b>	Yes	<b>Adjustable feet</b>	Just for levelling
<b>End of cycle indicator</b>	On display, with acoustic signal	<b>Insulation level</b>	Super
<b>Washing system</b>	Planetarium	<b>Back cover</b>	Yes, with covered counterweight
<b>Third spray arm</b>	Single	<b>Depth of dishwasher with open door (mm)</b>	1168 mm
<b>Water softener</b>	With electronic setting	<b>Removable top</b>	Yes, with optional KIT
		<b>Top cover</b>	In plastic

## Electrical Connection

<b>Connected power</b>	1800 W	<b>Type of connection</b>	Single-phase
<b>Current</b>	13 A	<b>Power supply cable length</b>	140 cm
<b>Voltage</b>	220-240 V	<b>Plug</b>	(G) UK e Singapore
<b>Frequency (Hz)</b>	50 Hz		

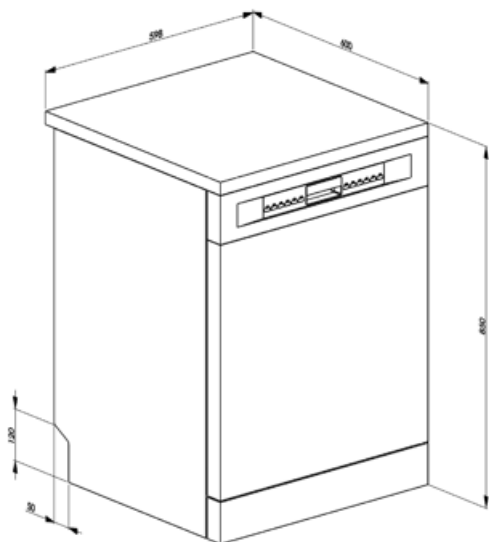

---

## Compatible Accessories

---

### KITGH

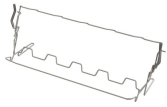

Kit glass holder. It has to be fitted on the first basket but only if there are foldable racks

### KITPLV2







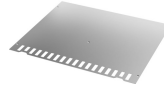















Kit extension for dishwasher and washing machine: lenght mt. 2

### KITINC



## Symbols glossary

-  A+: Energy efficiency class A+ helps to save up to 10% energy compared to class A. Maximum performance with minimum consumption is guaranteed.
-  To improve the drying of dishes without leaving stains.
-  LED display: to show programmes, functions and options selected and the time to the end of the cycle.
-  FlexiDuo: The FlexiDuo 3rd cutlery basket allows you to arrange cutlery or small cups, ladles, or bulky utensils however you like: it consists of two separate and moveable modules.
-  FlexiZone: The ½ load flexizone allows you to wash a reduced load saving energy, water and time and there are no restrictions on where the items are placed.
-  Noise Level: Excellent insulation and special devices keep noise to a minimum.
-  Auto 45°- 65°: The auto programme regulates the length of a cycle depending on the need for a pre-wash and the number of rinses required.
-  Eco: Eco, this economic wash programme uses a low amount of water and energy in order to provide the most environmentally friendly cleaning option.
-  Normal Quick: Program Normal Quick is suitable for quick washing of mixed dishes, for everyday use.
-  PRG\_STRONG\_72dpi
-  The Aquatest sensor is an electronic sensor that measures the degree of water transparency at the end of the initial soaking phase. Based on the values measured, the sensor sets the most suitable programme, thus obtaining the best washing results with the minimum amount of water.
-  Delay Timer: Option to postpone the start of the desired programme by up to 24 hours in order to programme the dishwasher to run at the desired time.
-  EasyGlide: Convenient EasyGlide system for easy unloading of the appliance that allows reaching maximum flexibility of load of the machine.
-  Ideal for multi-function detergents, this option allows washing to be optimised, with full benefits from the combined-action tablets. When this option is activated, any salt and rinse aid is used.
-  Hyclean: When the HYCLEAN option is selected, the dishwasher performs a final 10 minute rinse at a high temperature of 70°C, eliminating virtually all bacteria to achieve the highest possible standards of cleanliness. The Hyclean option can be selected with almost all cycles at temperatures above 50°C.
-  The Planetarium washing system, with high rotations per minute, guarantees complete coverage of the tank, thanks to the simultaneous rotation of base and sprayers, and excellent washing results.
-  Delicate Quick: Program Delicate Quick is suitable for quick washing of delicate dishes.
-  Eco: Eco, this economic wash programme uses a low amount of water and energy in order to provide the most environmentally friendly cleaning option.
-  Soak programme: The soak programme provides a rinse to prevent dirt from drying.
-  Super Quick: The super Quick programme is suitable for removing stubborn dirt fast.



13 place settings: Number of place settings.



Total Acquastop: In addition to the partial Acquastop protection present in all Smeg dishwashers, some models have an electronic device fitted to the water intake hose, which monitors water levels in the machine, detects leaks in the hose and switches off the water supply immediately when necessary.



System WaterSave ensures the best washing results with minimal water consumption depending on the model of dishwasher.