

DFFABCR



Product Family	Dishwashers
Width	60 cm
Commercial height	85 cm
Installation	Free-standing
N° baskets	3, FlexiDuo
Motor	Inverter 2.0
EAN code	8017709307875



Programmes



No. of programmes	10+1	Auto sensor 45-65	Yes
Washing temperatures	38, 45, 50, 55, 65, 70, 75 °C	Mix	Yes
Soak	Yes	Quiet (-2 dB)	Yes
Express 27'	Yes	Intense	Yes
Crystal	Yes	Self clean	Yes
Full express - 60 minutes	Yes	Hygiene 99,9%	Yes
ECO	Yes		

Options



Dry Assist+ option	Yes	1/2 load FlexiZone option (varied distribution)	Yes
Delay timer option	Up to 9 hours, with automatic soak	Special programs option	Yes

Baskets



Basket colour	Grey	Largest loadable dish in upper basket	19,0 cm
Basket components colour	Grey	Lower Basket	With 4 foldable racks

Handle	In plastic on upper and lower basket	Lower basket with anti-drip inserts	Yes
Upper Basket	With 3 foldable racks	Largest loadable dish in lower basket	30,0 cm
Glass holder	Yes	Colour Inner Components	Cup shelves, Handle, Anti drop inserts, Cutlery basket: same colour of Dishwasher
Height adjustment of the upper basket	On three levels	Cutlery basket	Yes
Upper basket with EasyGlide System	Yes		

Technical Features



Width (mm)	598 mm	Turbidity sensor Aquatest	Yes
Depth (mm)	627 mm	Flood protection system	Total Acquastop
Display type	1 digit	Water supply	Single; cold/hot water max. 60°C - energysave with hot water up to 35%
Product Height (mm)	885 mm	Max water hardness	100°FH;58°dH
Controls	Electronic	Drying system	Natural condenser drying, with Dry Assist + automatic door opening system at the end of the cycle
Display	Delayed start	Tank material	Stainless steel
Programme graphics	Symbols and label	Filter	Stainless steel
On/off indicator	Yes	Concealed heating element	Yes
Salt light indicator	Light	Hinges	Self balancing with fixed hinges
Rinse aid indicator	Light	Adjustable feet	Just for levelling
End of cycle indicator	Acoustic signal	Back cover	Yes
Washing system	Planetarium	Depth of dishwasher with open door (mm)	1171 mm
Third spray arm	Single	Top cover	In plastic
Water softener	With electronic setting		

Performance / Energy Label

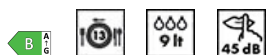

Energy Efficiency Class (Washing cycle)	B	Programme duration	4:25 h:min
Energy consumption [per 100 cycles, based on the eco programme]	63 kWh	Airborne acoustical noise emissions (spinning phase)	45 dB(A) re 1 pW
Rated capacity (ps)	13	Airborne acoustical noise emission class	C
Water consumption [per cycle]	9,0 litres	Energy efficiency Index (EEI) (Washing cycle)	37,9

Electrical Connection

Connected power	1800 W	Type of connection	Single-phase
Current	13 A	Power supply cable length	140 cm
Voltage	220-240 V	Plug	(G) UK e Singapore
Frequency (Hz)	50 Hz		

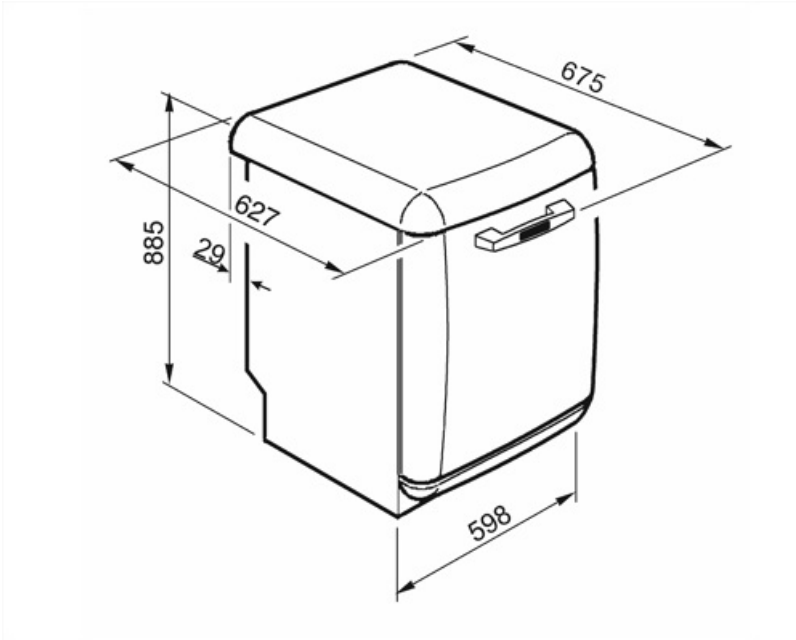

Compatible Accessories



KITGH

Kit glass holder. It has to be fitted on the first basket but only if there are foldable racks



KITINC

a steel bar fitted on the top will block the dishwasher at the top.



KITPLV2

Kit extension for dishwasher and washing machine: length mt. 2

























Alternative products



DFFABBL

Colour: Black

Symbols glossary

	Aquatest measures the clarity of the water during an auto program, and automatically ensures the minimum consumption of water and energy.		Anti-drip: Some models of dishwashers are equipped with special polymer nozzles anti-drip, that improve the process of drying.
	Delay Timer: The delay timer can postpone the start of the program by up to 24 hours.		EasyGlide: Convenient EasyGlide system for easy unloading of the appliance that allows reaching maximum flexibility of load of the machine.
	FlexiDuo: The FlexiDuo 3rd cutlery basket allows you to arrange cutlery or small cups, ladles, or bulky utensils however you like: it consists of two separate and moveable modules.		FlexiZone: The ½ load flexizone allows you to wash a reduced load saving energy, water and time and there are no restrictions on where the items are placed.
	Noise Level: Excellent insulation and special devices keep noise to a minimum.		PLANETARIUM_WASHING_SYSTEM_72dpi
	Auto 45°- 65°: The auto programme regulates the length of a cycle depending on the need for a pre-wash and the number of rinses required.		Crystals: The Crystals programme is dedicated to delicate dishes such as glasses and china.
	Eco: Eco, this economic wash programme uses a low amount of water and energy in order to provide the most environmentally friendly cleaning option.		Normal programme: The normal programme is suitable for normal degrees of dirt for everyday use.
	Soak programme: The soak programme provides a rinse to prevent dirt from drying.		Rapid 27 Mins: The rapid 27 mins quick program takes just 27 minutes to wash a load.
	Ultraclean: The Ultraclean option performs a final rinse at a high temperature of 70°C eliminating virtually all bacteria.		The symbols show the number of plate settings of the dishwasher.
	Total Acquastop: In addition to the partial Acquastop protection present in all Smeg dishwashers, some models have an electronic device fitted to the water intake hose, which monitors water levels in the machine, detects leaks in the hose and switches off the water supply immediately when necessary.		System WaterSave ensures the best washing results with minimal water consumption depending on the model of dishwasher.
	Quick wash cycle for normally soiled mixed loads such as dishes and pans, even with dried-on residues. Dishes are washed and dried in 60 minutes.		Dishwasher cleaning cycle. The cycle should be started with the machine empty, without dishes. It is recommended to run the program every 2-3 months, using special dishwasher detergents.
	SILENT: Wash cycle suitable for normally soiled dishes, even with dried-on residues. Ensures maximum noise reduction and is therefore ideal if you wish to run it during the night.		Allows you to enable additional programs when selected together with any wash cycle.
	The Dry Assist + option, in addition to saving energy, ensures perfect drying of the dishes by opening the door automatically at the end of the wash c		Energy efficiency class B



HYGIENE 99.9% High-temperature washing programme. The 75° rinse guarantees the removal of 99.9% of germs and bacteria, making it ideal for sanitising



The work aimed at continuous improvement has allowed the creation of the second generation of the Inverter motor 2.0, characterised by greater efficiency and durability over time, which allows very high performance and a lower energy consumption and noise level.