

# DFFABCR



<b>Product Family</b>	Dishwashers
<b>Commercial width</b>	60 cm
<b>Commercial height</b>	85 cm
<b>Installation</b>	Free-standing
<b>N° baskets</b>	3, FlexiDuo
<b>Motor</b>	Inverter 2.0
<b>EAN code</b>	8017709307875



## Programs



<b>N. of programmes</b>	10+1	<b>Auto sensor 45-65</b>	Yes
<b>Washing temperatures</b>	38, 45, 50, 55, 65, 70, 75 °C	<b>Mix</b>	Yes
<b>Soak</b>	Yes	<b>Quiet (-2 dB)</b>	Yes
<b>Express 27'</b>	Yes	<b>Intense</b>	Yes
<b>Crystal</b>	Yes	<b>Self clean</b>	Yes
<b>Full express - 60 minutes</b>	Yes	<b>Hygiene 99,9%</b>	Yes
<b>ECO</b>	Yes		

## Options



<b>Dry Assist+ option</b>	Yes	<b>1/2 load FlexiZone option</b>	Yes
<b>Delay timer option</b>	Up to 9 hours	<b>Special programs option</b>	Yes

## Baskets



<b>Basket colour</b>	Grey	<b>Largest loadable dish in upper basket</b>	19,0 cm
<b>Basket components colour</b>	Grey	<b>Lower Basket</b>	With 4 foldable racks
<b>Handle</b>	In plastic on upper and lower basket	<b>Lower basket with anti-drip inserts</b>	Yes

<b>Upper Basket</b>	With 3 foldable racks	<b>Largest loadable dish in lower basket</b>	30,0 cm
<b>Glass holder</b>	Yes	<b>Colour Inner Components</b>	Cup shelves, Handle, Anti drop inserts, Cutlery basket: same colour of Dishwasher
<b>Height adjustment of the upper basket</b>	On three levels (5 cm)	<b>Cutlery basket</b>	Yes
<b>Upper basket with EasyGlide System</b>	Yes		

## Technical Features



<b>Width (mm)</b>	598 mm	<b>Turbidity sensor Aquatest</b>	Yes
<b>Depth (mm)</b>	627 mm	<b>Flood protection system</b>	Total Acquastop
<b>Display type</b>	LED display (1 digit)	<b>Water supply</b>	Single; cold/hot water max. 60°C - energysave with hot water up to 35%
<b>Product Height (mm)</b>	885 mm	<b>Max water hardness</b>	100°FH;58°dH
<b>Controls</b>	Electronic	<b>Drying system</b>	Natural condenser drying, with Dry Assist + automatic door opening system at the end of the cycle
<b>Display</b>	Delayed start	<b>Tube material</b>	Stainless steel
<b>Programme graphics</b>	Symbols and label	<b>Filter</b>	Stainless steel
<b>On/off indicator</b>	Yes	<b>Concealed heating element</b>	Yes
<b>Salt light indicator</b>	Light	<b>Hinges</b>	Self balancing with fixed hinges
<b>Rinse aid indicator</b>	Light	<b>Adjustable feet</b>	Just for levelling
<b>End of cycle indicator</b>	Acoustic signal	<b>Back cover</b>	Yes
<b>Washing system</b>	Planetarium	<b>Depth of dishwasher with open door (mm)</b>	1171 mm
<b>Third spray arm</b>	Single	<b>Top cover</b>	In plastic
<b>Water softener</b>	With electronic setting		

## Performance / Energy Label - Reg. 2019

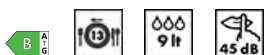

<b>Energy Efficiency Class</b>	B	<b>Programme duration</b>	4:25 h:min
<b>Energy consumption [per 100 cycles, based on the eco programme]</b>	63 kWh	<b>Airborne acoustical noise emissions</b>	45 dB(A) re 1 pW
<b>Rated capacity (ps)</b>	13	<b>Airborne acoustical noise emission class</b>	C
<b>Water consumption [per cycle]</b>	9.0 litres	<b>Energy efficiency Index (EEI)</b>	37.9

## Electrical Connection

<b>Connected power</b>	1800 W	<b>Type of connection</b>	Single-phase
<b>Current</b>	13 A	<b>Power supply cable length</b>	140 cm
<b>Voltage</b>	220-240 V	<b>Plug</b>	(G) UK e Singapore
<b>Frequency (Hz)</b>	50 Hz		

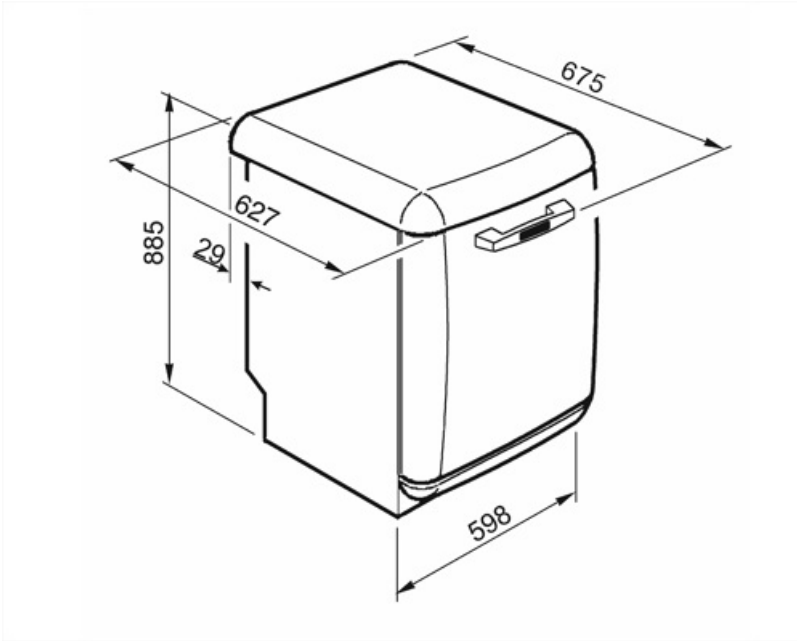

---

## Compatible Accessories

---

### KITGH



Kit glass holder. It has to be fitted on the first basket but only if there are foldable racks

### KITPLV2



Kit extension for dishwasher and washing machine: lenght mt. 2

### KITINC



## Alternative products





















---



**DFFABBL**

**Colour: Black**

## Symbols glossary

	<p>The Aquatest sensor is an electronic sensor that measures the degree of water transparency at the end of the initial soaking phase. Used on the values measured, the sensor sets the most suitable programme, thus obtaining the best washing results with the minimum amount of water.</p>		<p>To improve the drying of dishes without leaving stains.</p>
	<p>Energy efficiency class B</p>		<p>Delay Timer: Option to postpone the start of the desired programme by up to 24 hours in order to programme the dishwasher to run at the desired time.</p>
	<p>The Dry Assist + option, in addition to saving energy, ensures perfect drying of the dishes by opening the door automatically at the end of the washing cycle.</p>		<p>EasyGlide: Convenient EasyGlide system for easy unloading of the appliance that allows reaching maximum flexibility of load of the machine.</p>
	<p>FlexiDuo: The FlexiDuo 3rd cutlery basket allows you to arrange cutlery or small cups, ladles, or bulky utensils however you like: it consists of two separate and moveable modules.</p>		<p>FlexiZone: The ½ load flexizone allows you to wash a reduced load saving energy, water and time and there are no restrictions on where the items are placed.</p>
	<p>The work aimed at continuous improvement has allowed the creation of the second generation of the Inverter motor 2.0, characterised by greater efficiency and durability over time, which allows very high performance and a lower energy consumption and noise level.</p>		<p>Noise Level: Excellent insulation and special devices keep noise to a minimum.</p>
	<p>The Planetarium washing system, with high rotations per minute, guarantees complete coverage of the tank, thanks to the simultaneous rotation of base and sprayers, and excellent washing results.</p>		<p>Auto 45°- 65°: The auto programme regulates the length of a cycle depending on the need for a pre-wash and the number of rinses required.</p>
	<p>Crystals: The Crystals programme is dedicated to delicate dishes such as glasses and china.</p>		<p>Eco: Eco, this economic wash programme uses a low amount of water and energy in order to provide the most environmentally friendly cleaning option.</p>
	<p>Quick wash cycle for normally soiled mixed loads such as dishes and pans, even with dried-on residues. Dishes are washed and dried in 60 minutes.</p>		<p>Mix: The Mix programme is suitable for mixed crockery and everyday pots and pans, without any particular incrustation.</p>
	<p>Soak programme: The soak programme provides a rinse to prevent dirt from drying.</p>		<p>Express 27': The Express 27' programme is a quick wash cycle, at low temperatures, for lightly soiled dishes.</p>
	<p>Ultraclean: The Ultraclean option performs a final rinse at a high temperature of 70°C eliminating virtually all bacteria.</p>		<p>13 place settings: Number of place settings.</p>



**Total Acquastop:** In addition to the partial Acquastop protection present in all Smeg dishwashers, some models have an electronic device fitted to the water intake hose, which monitors water levels in the machine, detects leaks in the hose and switches off the water supply immediately when necessary.



**Dishwasher cleaning cycle.** The cycle should be started with the machine empty, without dishes. It is recommended to run the program every 2-3 months, using special dishwasher detergents.



Allows you to enable additional programs when selected together with any wash cycle.



**System WaterSave** ensures the best washing results with minimal water consumption depending on the model of dishwasher.



**SILENT:** Wash cycle suitable for normally soiled dishes, even with dried-on residues. Ensures maximum noise reduction and is therefore ideal if you wish to run it during the night.



**HYGIENE 99.9%** High-temperature washing programme. The 75° rinse guarantees the removal of 99.9% of germs and bacteria.