

DI361C



Product Family	Dishwashers
Width	60 cm
Commercial height	82 cm
Installation	Fully-integrated built-in
Kitchen panel	Not supplied
N° baskets	3, Flexi
EAN code	8017709307837



Programmes



No. of programmes	10	ECO	Yes
Washing temperatures	38, 45, 50, 55, 65, 70, 75 °C	Mix	Yes
Soak	Yes	Quiet (-2 dB)	Yes
Express 27'	Yes	Intense	Yes
Crystal	Yes	Hygiene 99,9%	Yes
Full express - 60 minutes	Yes	Daily 1/2 load	Yes

Options



Delay timer option	3-6-9 hours, with automatic soak	Special programs option	Yes
--------------------	----------------------------------	-------------------------	-----

Baskets



Basket colour	Grey	Largest loadable dish in upper basket	19,0 cm
Basket components colour	Grey	Lower Basket	With 2 foldable racks
Handle	In plastic on upper and lower basket	Lower basket with anti-drip inserts	Yes
Upper Basket	With 1 foldable rack	Largest loadable dish in lower basket	30,0 cm
Glass holder	Yes		

Height adjustment of the upper basket	On three levels	Colour Inner Components	Blue
---------------------------------------	-----------------	-------------------------	------

Technical Features



Width (mm)	598 mm	Max water hardness	100°FH;58°dH
Depth (mm)	570 mm	Drying system	Natural condenser drying, with Dry Assist + automatic door opening system at the end of the cycle
Product Height (mm)	818 mm	Steam protection	In plastic
Controls	Electronic	Tank material	Stainless steel
Programme graphics	Symbols	Filter	Stainless steel
On/off indicator	Yes	Concealed heating element	Yes
Salt light indicator	Light	Hinges	Self balancing with fixed hinges
Rinse aid indicator	Light	Min. and max. frontal panel weight	2 - 9 kg
End of cycle indicator	Acoustic signal	Min. and max plinth height	100 - 228 mm
Washing system	Orbital	Adjustable feet	7cm, from 820 to 890 mm
Third spray arm	Single	Back cover	Yes
Water softener	With electronic setting	Depth of dishwasher with open door (mm)	1146
Flood protection system	Total Acquastop	Back feet adjustable from front	Yes
Water supply	Single; cold/hot water max. 60°C - energysave with hot water up to 35%	Top cover	In plastic

Performance / Energy Label NEW

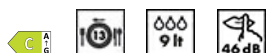

Energy Efficiency Class (Washing cycle)	C	Programme duration	4:25 h:min
Energy consumption [per 100 cycles, based on the eco programme]	73 kWh	Airborne acoustical noise emissions (spinning phase)	46 dB(A) re 1 pW
Rated capacity (ps)	13	Airborne acoustical noise emission class	C
Water consumption [per cycle]	9,0 litres	Energy efficiency Index (EEI) (Washing cycle)	43,8

Electrical Connection

Plug	(G) UK e Singapore	Frequency (Hz)	50 Hz
Connected power	1800 W	Type of connection	Single-phase
Current	13 A	Power supply cable length	140 cm
Voltage	220-240 V		

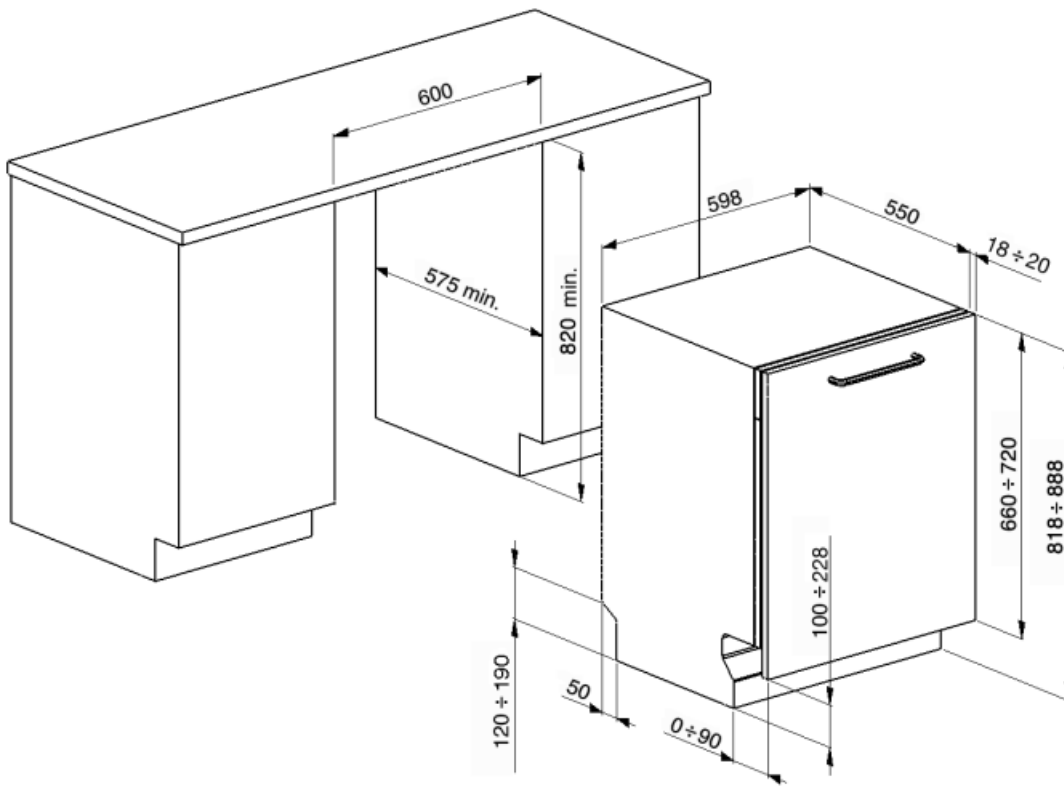

Not included accessories

KITPL60FABB

Toeckick Kit in White colour with adjustable height. Can be fitted over all the fully integrated and underbench models with Fixed Fulcrum. Can be installed also on the models with variable fulcrum or flexifit hinges.



KITPL60FABX

Toeckick Kit in Stainless Steel with adjustable height. Can be fitted over all the fully integrated and underbench models with Fixed Fulcrum. Can be installed also on the models with variable fulcrum or flexifit hinges.



KIT82CX



KITPL60FABN

Toeckick Kit in Black colour with adjustable height. Can be fitted over all the fully integrated and underbench models with Fixed Fulcrum. Can be installed also on the models with variable fulcrum or flexifit hinges.



KITPLV2

Kit extension for dishwasher and washing machine: length mt. 2



KITGH



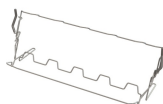

















Kit glass holder. It has to be fitted on the first basket but only if there are foldable racks



KIT82CN



Symbols glossary

	Anti-drip: Some models of dishwashers are equipped with special polymer nozzles anti-drip, that improve the process of drying.		COMM_HEIGHT_82_72dpi
	Delay Timer: The delay timer can postpone the start of the program by up to 24 hours.		Noise Level: Excellent insulation and special devices keep noise to a minimum.
	Orbital wash system distributes water evenly throughout the 60cm dishwasher cavity, directing water with precision to ensure an excellent wash.		Crystals: The Crystals programme is dedicated to delicate dishes such as glasses and china.
	1/2 load: This program is designed for washing dishes not heavily soiled with partial load of the dishwasher.		Eco: Eco, this economic wash programme uses a low amount of water and energy in order to provide the most environmentally friendly cleaning option.
	Normal programme: The normal programme is suitable for normal degrees of dirt for everyday use.		Soak programme: The soak programme provides a rinse to prevent dirt from drying.
	Rapid 27 Mins: The rapid 27 mins quick program takes just 27 minutes to wash a load.		Ultraclean: The Ultraclean option performs a final rinse at a high temperature of 70°C eliminating virtually all bacteria.
	The symbols show the number of plate settings of the dishwasher.		Total Acquastop: In addition to the partial Acquastop protection present in all Smeg dishwashers, some models have an electronic device fitted to the water intake hose, which monitors water levels in the machine, detects leaks in the hose and switches off the water supply immediately when necessary.
	System WaterSave ensures the best washing results with minimal water consumption depending on the model of dishwasher.		...
	...		...
	Energy efficiency class C		HYGIENE 99.9% High-temperature washing programme. The 75° rinse guarantees the removal of 99.9% of germs and bacteria, making it ideal for sanitising