

DIL324AQL



Product Family	Dishwashers
Width	60 cm
Commercial height	82 cm
Installation	Fully-integrated built-in
Kitchen panel	Not supplied
N° baskets	3, FlexiDuo with Easy Glide
Motor	Inverter 2.0
EAN code	8017709364465



Programmes



No. of programmes	12+2	Auto sensor 45-65	Yes
Washing temperatures	38, 45, 50, 55, 65, 70, 75 °C	Mix	Yes
Soak	Yes	Quiet (-2 dB)	Yes
Express 27'	Yes	Intense	Yes
Crystal	Yes	Self clean	Yes
Full express - 60 minutes	Yes	Hygiene 99,9%	Yes
ECO	Yes	Delicate	Yes
Green express	Yes	Trays	Yes

Options



Dry Assist+ option	Yes	Intensive wash zone option	
Delay timer option	Up to 24 hours, with automatic soak	Special programs option	Yes
1/2 load FlexiZone option (varied distribution)	Yes	Clean&Shine option	Yes

Baskets



Basket colour	Grey	Largest loadable dish in upper basket	19,0 cm
---------------	------	---------------------------------------	---------

Basket components colour	Grey	Lower Basket	With 4 foldable racks
Handle	In plastic with stainless steel insert on upper and lower basket	Lower basket accessories	MultiLoad, ProFlex Holder, WinePro
Upper Basket	With 3 foldable racks	Lower basket with anti-drip inserts	Yes
Height adjustment of the upper basket	On three levels	Largest loadable dish in lower basket	30,0 cm
Sliding Guides Extra Glide	Yes	Colour Inner Components	Sage Leaf

Technical Features



Width (mm)	598 mm	Water supply	Single; cold/hot water max. 60°C - energysave with hot water up to 35%
Depth (mm)	545 mm	Max water hardness	100°FH;58°dH
Display type	LED display	Drying system	Natural condenser drying, with Dry Assist + automatic door opening system at the end of the cycle
Product Height (mm)	818 mm	Steam protection	In plastic
Controls	Electronic touch control	Tank material	Stainless steel
Display	Delayed start, Programme time indicator, Consumptions	Filter	Stainless steel
Programme graphics	Symbols	Concealed heating element	Yes
On/off indicator	Yes	Hinges	Self balancing, Sliding, FLEXIFIT
Salt light indicator	Light	Min. and max. frontal panel weight	2 - 11 kg
Rinse aid indicator	Light	Min. and max plinth height	50 - 215 mm
End of cycle indicator	ActiveLight	Can be installed in-column	Yes
Auto switch-off	Yes	Adjustable feet	7cm, from 820 to 890 mm
Washing system	Planetarium	Additional gaskets	Yes, with stainless steel plate
Third spray arm	Single	Back cover	Yes
Water softener	With electronic setting	Depth of dishwasher with open door (mm)	1146 mm
Turbidity sensor	Yes	Back feet adjustable from front	Yes
Aquatest		Top cover	In plastic
Flood protection system	Total Acquastop		

Performance / Energy Label



Energy Efficiency Class (Washing cycle)	A	Programme duration	4:35 h:min
--	---	---------------------------	------------

Energy consumption [per 100 cycles, based on the eco programme]	54 kWh	Airborne acoustical noise emissions (spinning phase)	42 dB(A) re 1 pW
Rated capacity (ps)	14	Airborne acoustical noise emission class	B
Water consumption [per cycle]	10.5 litres	Energy efficiency Index (EEI) (Washing cycle)	31.8

Electrical Connection

Connected power	1800 W	Type of connection	Single-phase
Current	13 A	Power supply cable length	140 cm
Voltage	220-240 V	Plug	(G) UK e Singapore
Frequency (Hz)	50 Hz		

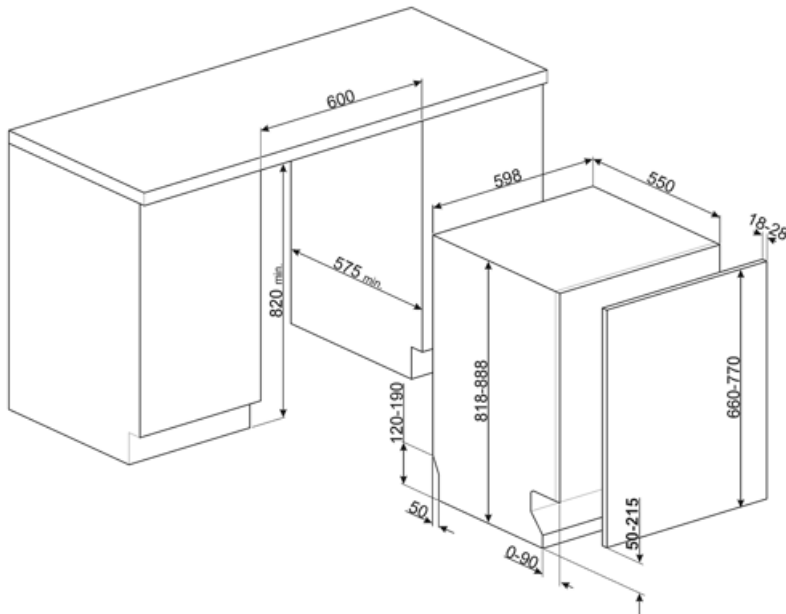

Compatible Accessories



KIT82CN



KIT82SPRAN



KIT82SPRX



KIT82CX



KIT82SPRMW



KITFLEXI

Kit for 60cm dishwashers with FlexiFit hinges for door panel weight >11 kg (max 15 kg 82 cm and 13,5 kg 86 cm)



KITGH

Kit glass holder. It has to be fitted on the first basket but only if there are foldable racks



KITPL60B

Toe-kick Kit in White colour with adjustable height and deepness. Can be installed over all the fully integrated and underbench models with variable fulcrum or flexifit hinges.



KITPL60N

Toe-kick Kit in Black colour with adjustable height and deepness. Can be installed over all the fully integrated and underbench models with variable fulcrum or flexifit hinges.

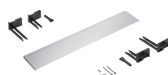

KITPL60X























Toe-kick Kit in Stainless Steel with adjustable height and deepness. Can be fitted over all the fully integrated and underbench models with variable fulcrum or flexifit hinges.















KITPLV2

Kit extension for dishwasher and washing machine: length mt. 2

Symbols glossary

 <p>Activelight is an led light which projects a red spot onto the floor beneath the dishwasher when the appliance is in use.</p>	 <p>Aquatest measures the clarity of the water during an auto program, and automatically ensures the minimum consumption of water and energy.</p>
 <p>Anti-drip: Some models of dishwashers are equipped with special polymer nozzles anti-drip, that improve the process of drying.</p>	 <p>Installation in column: Installation in column</p>
 <p>COMM_HEIGHT_82_72dpi</p>	 <p>Delay Timer: The delay timer can postpone the start of the program by up to 24 hours.</p>
 <p>FlexiDuo: The FlexiDuo 3rd cutlery basket allows you to arrange cutlery or small cups, ladles, or bulky utensils however you like: it consists of two separate and moveable modules.</p>	 <p>Models with new Flexi Fit hinges are able to be installed in kitchens with a plinth of just 5cms. With this new hinge design, the panel has a sliding movement from the bottom to the top, avoiding any possible interference of the panel with the plinth.</p>
 <p>FlexiZone: The ½ load flexizone allows you to wash a reduced load saving energy, water and time and there are no restrictions on where the items are placed.</p>	 <p>The new ExtraGlide guide system, available on top of the range models, makes the second basket even smoother and softer. In fact, it facilitates the extraction of the introduction, even at full load and, for the greater excursion, the insertion of crockery is also facilitated in the rear part.</p>
 <p>Noise Level: Excellent insulation and special devices keep noise to a minimum.</p>	 <p>PLANETARIUM_WASHING_SYSTEM_72dpi</p>
 <p>Auto 45°- 65°: The auto programme regulates the length of a cycle depending on the need for a pre-wash and the number of rinses required.</p>	 <p>Crystals: The Crystals programme is dedicated to delicate dishes such as glasses and china.</p>
 <p>Delicate: Delicate washing program is designed for delicate dishes which are not heavily soiled.</p>	 <p>Eco: Eco, this economic wash programme uses a low amount of water and energy in order to provide the most environmentally friendly cleaning option.</p>
 <p>Normal programme: The normal programme is suitable for normal degrees of dirt for everyday use.</p>	 <p>Soak programme: The soak programme provides a rinse to prevent dirt from drying.</p>
 <p>Rapid 27 Mins: The rapid 27 mins quick program takes just 27 minutes to wash a load.</p>	 <p>Ultraclean: The Ultraclean option performs a final rinse at a high temperature of 70°C eliminating virtually all bacteria.</p>
 <p>The symbols show the number of plate settings of the dishwasher.</p>	 <p>Total Acquastop: In addition to the partial Acquastop protection present in all Smeg dishwashers, some models have an electronic device fitted to the water intake hose, which monitors water levels in the machine, detects leaks in the hose and switches off the water supply immediately when necessary.</p>

-  Touch controls: Easy to use touch controls allow the appliance to be programmed at the touch of a button.
-  GREEN EXPRESS Washing programme with low water and energy consumption.
-  Dishwasher cleaning cycle. The cycle should be started with the machine empty, without dishes. It is recommended to run the program every 2-3 months, using special dishwasher detergents.
-  Allows you to enable additional programs when selected together with any wash cycle.
-  Clean&Shine option: For perfect cleaning results, this option adds an extra rinse to the wash cycle, which also gives the dishes a higher gloss.
-  Energy efficiency class A
-  The work aimed at continuous improvement has allowed the creation of the second generation of the Inverter motor 2.0, characterised by greater efficiency and durability over time, which allows very high performance and a lower energy consumption and noise level.
-  System WaterSave ensures the best washing results with minimal water consumption depending on the model of dishwasher.
-  Quick wash cycle for normally soiled mixed loads such as dishes and pans, even with dried-on residues. Dishes are washed and dried in 60 minutes.
-  SILENT: Wash cycle suitable for normally soiled dishes, even with dried-on residues. Ensures maximum noise reduction and is therefore ideal if you wish to run it during the night.
-  The Dry Assist + option, in addition to saving energy, ensures perfect drying of the dishes by opening the door automatically at the end of the wash cycle.
-  Baking tray programme: for intensive cleaning of the oven trays. Place the trays in the lower basket of the dishwasher.
-  HYGIENE 99.9% High-temperature washing programme. The 75° rinse guarantees the removal of 99.9% of germs and bacteria, making it ideal for sanitising.
- 