

DIL331C



Product Family	Dishwashers
Commercial width	60 cm
Commercial height	82 cm
Installation	Fully-integrated built-in
Kitchen panel	Not supplied
N° baskets	3, Flexi
Motor	Inverter 2.0
EAN code	8017709364434



Programs



N. of programmes	10+1	ECO	Yes
Washing temperatures	38, 45, 50, 55, 65, 70, 75 °C	Mix	Yes
Soak	Yes	Quiet (-2 dB)	Yes
Express 27'	Yes	Intense	Yes
Crystal	Yes	Hygiene 99,9%	Yes
Full express - 60 minutes	Yes	1/2 load	Yes

Options



Delay timer option	3-6-9 hours	Special programs option	Yes
---------------------------	-------------	--------------------------------	-----

Baskets



Basket colour	Grey	Lower Basket	With 2 foldable racks
Basket components colour	Grey	Lower basket accessories	MultiLoad
Handle	In plastic on upper and lower basket	Lower basket with anti-drip inserts	Yes
Upper Basket	With 1 foldable rack	Largest loadable dish in lower basket	30,0 cm
Height adjustment of the upper basket	On three levels (5 cm)	Colour Inner Components	Sage Leaf

Largest loadable dish in upper basket 19,0 cm

Technical Features



Width (mm)	598 mm	Water supply	Single; cold/hot water max. 60°C - energysave with hot water up to 35%
Depth (mm)	545 mm	Max water hardness	100°FH;58°dH
Display type	LED display (3 digit)	Drying system	Natural condenser drying, with Dry Assist + automatic door opening system at the end of the cycle
Product Height (mm)	818 mm	Steam protection	In plastic
Controls	Electronic	Tube material	Stainless steel
Display	Delayed start, Programme time indicator	Filter	Stainless steel
Programme graphics	Symbols	Concealed heating element	Yes
Salt light indicator	Light	Hinges	Self balancing, Sliding, FLEXIFIT
Rinse aid indicator	Light	Min. and max. frontal panel weight	2,5 - 11 kg
End of cycle indicator	Acoustic signal	Min. and max plinth height	50 - 215 mm
Auto switch-off	Yes	Adjustable feet	7 cm, from 820 to 890 mm
Washing system	Orbital	Back cover	Yes
Third spray arm	Single	Depth of dishwasher with open door (mm)	1168 mm
Water softener	With electronic setting	Back feet adjustable from front	Yes
Flood protection system	Total Acquastop	Top cover	In plastic

Performance / Energy Label - Reg. 2019

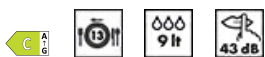

Energy Efficiency Class	C	Programme duration	4:25 h:min
Energy consumption [per 100 cycles, based on the eco programme]	73 kWh	Airborne acoustical noise emissions	43 dB(A) re 1 pW
Rated capacity (ps)	13	Airborne acoustical noise emission class	B
Water consumption [per cycle]	9.0 litres	Energy efficiency Index (EEI)	43.8

Electrical Connection

Connected power	1800 W	Type of connection	Single-phase
Current	13 A	Power supply cable length	140 cm
Voltage	220-240 V	Plug	(G) UK e Singapore
Frequency (Hz)	50 Hz		

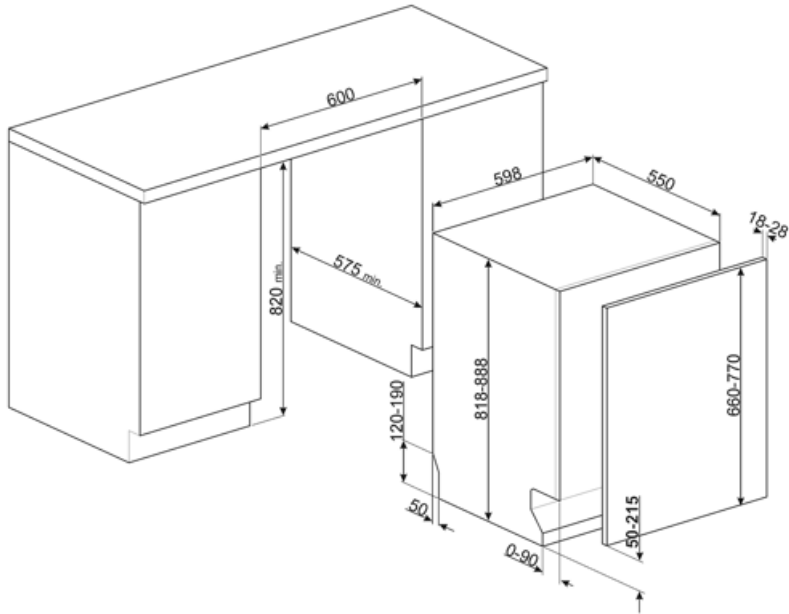

Compatible Accessories



KIT82CN



KIT82SPRAN



KIT82SPRX



KIT82CX



KIT82SPRMW



KITFLEXI

Kit for 60cm dishwashers with FlexiFit hinges for door panel weight >11 kg (max 15 kg 82 cm and 13,5 kg 86 cm)



KITGH

Kit glass holder. It has to be fitted on the first basket but only if there are foldable racks



KITPL60B

Toe-kick Kit in White colour with adjustable height and deepness. Can be installed over all the fully integrated and underbench models with variable fulcrum or flexifit hinges.



KITPL60N

Toe-kick Kit in Black colour with adjustable height and deepness. Can be installed over all the fully integrated and underbench models with variable fulcrum or flexifit hinges.



KITPL60X























Toe-kick Kit in Stainless Steel with adjustable height and deepness. Can be fitted over all the fully integrated and underbench models with variable fulcrum or flexifit hinges.



KITPLV2

Kit extension for dishwasher and washing machine: lenght mt. 2

Symbols glossary

 To improve the drying of dishes without leaving stains.	 Energy efficiency class C
 82 cm high	 Delay Timer: Option to postpone the start of the desired programme by up to 24 hours in order to programme the dishwasher to run at the desired time.
 The FlexiFit hinges allow the kitchen panel to slide over the dishwasher door, allowing a minimum kitchen plinth height of 5 cm.	 The work aimed at continuous improvement has allowed the creation of the second generation of the Inverter motor 2.0, characterised by greater efficiency and durability over time, which allows very high performance and a lower energy consumption and noise level.
 Noise Level: Excellent insulation and special devices keep noise to a minimum.	 Orbital wash system distributes water evenly throughout the 60cm dishwasher cavity, directing water with precision to ensure an excellent wash.
 Crystals: The Crystals programme is dedicated to delicate dishes such as glasses and china.	 1/2 load: This program is designed for washing dishes not heavily soiled with partial load of the dishwasher.
 Eco: Eco, this economic wash programme uses a low amount of water and energy in order to provide the most environmentally friendly cleaning option.	 Quick wash cycle for normally soiled mixed loads such as dishes and pans, even with dried-on residues. Dishes are washed and dried in 60 minutes.
 Mix: The Mix programme is suitable for mixed crockery and everyday pots and pans, without any particular incrustation.	 SILENT: Wash cycle suitable for normally soiled dishes, even with dried-on residues. Ensures maximum noise reduction and is therefore ideal if you wish to run it during the night.
 Allows you to enable additional programs when selected together with any wash cycle.	 Soak programme: The soak programme provides a rinse to prevent dirt from drying.
 Express 27': The Express 27' programme is a quick wash cycle, at low temperatures, for lightly soiled dishes.	 HYGIENE 99.9% High-temperature washing programme. The 75° rinse guarantees the removal of 99.9% of germs and bacteria.
 Ultraclean: The Ultraclean option performs a final rinse at a high temperature of 70°C eliminating virtually all bacteria.	 13 place settings: Number of place settings.
 Total Acquastop: In addition to the partial Acquastop protection present in all Smeg dishwashers, some models have an electronic device fitted to the water intake hose, which monitors water levels in the machine, detects leaks in the hose and switches off the water supply immediately when necessary.	 System WaterSave ensures the best washing results with minimal water consumption depending on the model of dishwasher.