

DN10SEC

EAN Code	8017709360092
Product Family	Tumble dryer
Commercial width	60 cm
Installation	Free-standing
Drying system	Heat pump condenser
Load type	Frontal



Aesthetics



Colour	White	Front panel type	NovaCare
Front panel colour	White	Door colour	White with Silver ring
LED/display colour	White	Door handle color	White
Function buttons colour	Black	Cabinet colour	White
Control knob colour	White / Silver		

Programs



Controls	Electronics
Programme graphics	Written in IT
No. of programmes	15
Programmes	

 Cotton ECO	 Rapid	 Hygiene Drying
 Refresh Hygiene	 Steam Refresh	 Outdoor/Sportswear
 Cotton	 Synthetic	 Silent
 Shirts	 Jeans	 Mix
 Timed Programmes	 Wool	 Duvet

Special programmes

 Hygiene Drying	Refresh Hygiene	Steam Refresh
 Wool	 Shirts	

Display

Drying Level	Program duration	Time Drying
Delay start	Residual time indicator	
Display type		
Programme progress indicator		
End of cycle indicator		
Clean filter indicator	Yes	
Condenser container full indicator	Yes	

Technical Features



Type of motor	Brushless/Inverter	Transparent door	Yes
Functioning	Electronic control	Door size	40 cm
Humidity sensor	Yes	Max. door opening angle	155 °
Time drying selection	From 10 to 160 min	Door hinges	Right
Cooling down phase	Yes	Reversible door	Yes
Anti-iron phase	Yes	Child lock (programme set lock)	Yes
Alternate drum rotation	Yes	Water condenser position	At the top
Internal light	Yes	Heating pump system	Yes
Combined filter	Yes	Type of cooling gas	R290
Fluff filter	Yes	Amount of cooling gas in kg	0.140
Drum material	Stainless steel	Condenser water drain hose	Yes
Drum volume	127 l	Column installation, with compatible washing-machine	With stacking kit, available as optional accessory

Performance / Energy label – Reg 2023



Load capacity (cotton)	10 kg	Energy efficiency class	C
Noise level for the standard cotton programme at full load	64 dB(A) re 1 pW	Weighted energy consumption in kWh per drying cycle	1,17

Time of the standard cotton program at full load	220 min	Acoustic airborne noise emission class	B
Time of the standard cotton program at partial load	125 min	Condensation efficiency class	B
Type	Condensing	Condensation efficiency	88 %

Electrical Connection

Connected power	800 W	Frequency (Hz)	50 Hz
Current	10 A	Power supply cable length	150 cm
Voltage (V)	230-240 V	Plug	(F;E) Schuko

Logistic Information

Width (mm)	598 mm	Product Height (mm)	846 mm
Depth (mm)	671 mm		

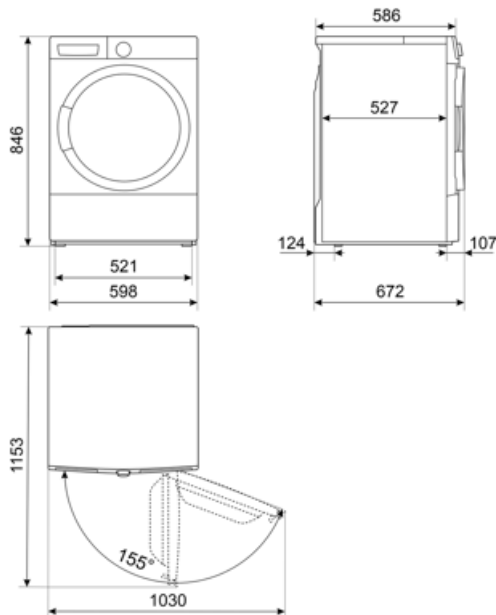

Compatible Accessories



























KITSPNC

Stacking kit dedicated to WN & DN
Dimension (mm): L598xH35xP618

KITSTWD

Symbols glossary

 <p>Easy Iron: this is an option which can be selected to ensure the finished laundry is left with less creases to make ironing easier.</p>	 <p>Child lock: some models are fitted with a device to lock the programme/cycle so it cannot be accidentally changed.</p>
 <p>Delay timer: can be set to run the programme at a convenient time or to take advantage of off-peak energy periods.</p>	 <p>LED display: to show programmes, functions and options selected and the time to the end of the cycle.</p>
 <p>C: Product energy rating</p>	 <p>40 cm: Large loading hatch of 40 cm in diameter, makes laundry loading and unloading easier and faster with maximum ease of use.</p>
 <p>Humidity sensor: allows to adjust dryer to obtain the desired drying level (Iron dry, Cupboard dry and Extra dry), saving time and reducing energy consumption. In addition, manual adjusting allows you to program drying time according to your preferences.</p>	 <p>End: Show the stage at which the program is in progress: the program has finished.</p>
 <p>Internal lights: help to illuminate the inside of the drum.</p>	 <p>Smeg's evolution towards more intelligent and eco-friendly models has led to the choice of Inverter technology, which significantly reduces consumption.</p>
 <p>Noise Level: Excellent insulation and special devices keep noise to a minimum.</p>	 <p>Eco 40-60: reference programme defined by EU regulations for measuring the energy performance of washing machines. Ideal for normally soiled cotton garments washable at 40 °C or 60 °C, it provides an excellent balance between cleaning performance and savings, although it requires a longer washing time.</p>
 <p>Program for drying cotton items including sheets, pillow cases, pajamas, lingerie, tablecloths, etc</p>	 <p>For fiber duvets indicating suitability on the label</p>
 <p>For high speed centrifuged jeans</p>	 <p>For synthetic fabrics without pigments and for cotton</p>
 <p>Short ventilation for cotton and linen garments without blowing hot air</p>	 <p>Gentle drying for shirts avoiding the formation of folds</p>
 <p>Selection of timed cycles at low temperatures.</p>	 <p>To dry wool clothes placed on a suitable basket</p>
 <p>Super fast: a programme designed to wash small amounts of laundry fast, ideal for washing lightly soiled garments.</p>	 <p>Shirts: a cycle to wash shirts in a short time with the utmost care, using a delicate spin for easy ironing.</p>
 <p>Sport: programme designed to quickly wash sports and technical clothing, which undergo frequent washes, ensuring optimal hygiene and protection of the fibres.</p>	 <p>Wool: this programme for wool or delicate fabrics uses slower rotations of the drum to ensure the utmost care for clothing.</p>



Steam Option: the steam is perfect for smoothing out creases, refreshing fabrics, neutralizing odors and releasing dirt, destroying allergens more quickly than by washing the item in water.



Shows the phase of program: Shows the phase in which the program is being.



Special program for garments / fabrics, such as children's clothes, which require sanitized and delicate washing.



The noise level is minimized



Program for delicately treating garments in synthetic or mixed fabrics, such as t-shirts and blouses.



Energy efficiency class C