

# DNP08SECIN

EAN Code	8017709362867
Product familie	Droger
Commerciële breedte	60 cm
Commerciële diepte	Standard (54 cm)
Installatie	Vrijstaand
Droogstelsysteem	Condens en warmtepomp
Type lading	Voorlader















## Design

Door window	Giant door	Kleur knop	Black/Chrome
Kleur	Wit	Type voorpaneel	NovaCare
Kleur voorpaneel	Wit	Kleur deur	Black with chrome ring
Kleur LED/ display	Wit	Kleur handgreep deur	Zwart
Kleur functietoetsen	Zwart	Kleur behuizing	Wit



## Programma's

Bediening	Elektronisch
Grafische weergave programma's	Tekst IT
Aantal programma's	15

### Programma's

 Cotton ECO	 Rapid	 Hygiene Drying
 Refresh Hygiene	 Steam Refresh	 Outdoor/Sportswear
 Katoen	 Synthetic	 Silent
 Overhemden	 Jeans	 Gemixed
 Getimedede programma's	 Wol	 Beddengoed

## Speciale programma's

 Hygiene Drying	Refresh Hygiene	Steam Refresh
 Wol	 Overhemden/ Blouses	

## Display

Drying Level	Program duration	Time Drying
--------------	------------------	-------------

Start uitstel	Weergave resttijd
---------------	-------------------

## Type display



## Programmavoortgang indicator



## Indicator einde cyclus



## Indicator reinigen filter

Ja

## Indicator legen condensreservoir

Ja

## Technische specificaties



Type motor	Inverter motor	Breedte deur	40 cm
Functionering	Elektronisch	Maximale openingshoek deur	155 °
Vochtsensor	Ja	Deurscharnieren	Rechts
Tijdselectie drogen	Van 10 tot 160 min	Deur omkeerbaar	Ja
Afkoelfase	Ja	Kinderbeveiliging	Ja
Anti-kreukfase na afloop drogen	Ja	Positie condensreservoir	Boven
Binnenverlichting	Ja	Warmtepompsysteem	Ja
Combined filter	Yes	Type koelgas	R290
Pluisjesfilter	Ja	Amount of cooling gas in kg	0.149
Materiaal trommel	Inox	Condensafvoerslang	Ja
Capaciteit trommel	110 l	Installatie in kolom, uitsluitend met compatibele modellen wasmachines	Met stapelkit, als accessoire verkrijgbaar
Transparante deur	Ja		

## Performance / Energy label – Reg 2023



Laadcapaciteit (katoen)	8 kg	Energy efficiency class	C
Geluidsniveau standaard Katoenprogramma bij hele belading	64 dB(A) re 1 pW	Weighted energy consumption in kWh per drying cycle	1,02
		Acoustic airborne noise emission class	B

Duur standaard programma katoen met hele belading 174 min

Duur standaard programma katoen halve belading 108 min

Type Condens

Condensation efficiency class B

Condensation efficiency 88 %

## Elektrische aansluiting

Aansluitwaarde 800 W  
Stroom 10 A  
Spanning (V) 230-240 V

Frequentie 50 Hz  
Lengte stroomkabel 150 cm  
Stekker (F;E) Schuko

## Logistieke informatie

Breedte product (mm) 598 mm  
Diepte product (mm) 607 mm

Hoogte product (mm) 846 mm

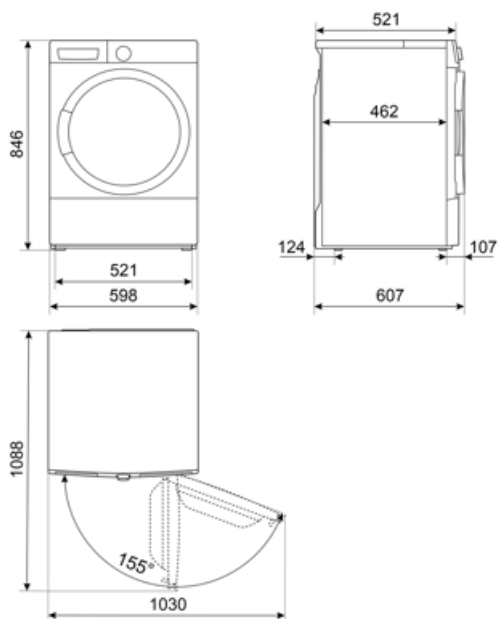

---

## Compatible Accessories

---



### KITSPNC























Stacking kit dedicated to WN & DN  
Dimension (mm): L598xH35xP618

### KITSTWD



### KITSPNC1

## Symbols glossary

 <p>A+++: Appliances with this symbol can reduce energy consumption by a further 30% from the standard A energy rating.</p>	 <p>Sommige modellen zijn voorzien van een functie om het programma/de cyclus te blokkeren zodat het niet per ongeluk kan aangepast worden.</p>
 <p>Delay timer: can be set to run the programme at a convenient time or to take advantage of off-peak energy periods.</p>	 <p>LED display: to show programmes, functions and options selected and the time to the end of the cycle.</p>
 <p>40 cm: Large loading hatch of 40 cm in diameter, makes laundry loading and unloading easier and faster with maximum ease of use.</p>	 <p>This shows the amount of laundry that can be inserted into the tumble dryer in KG.</p>
 <p>Humidity sensor: allows to adjust dryer to obtain the desired drying level (Iron dry, Cupboard dry and Extra dry), saving time and reducing energy consumption. In addition, manual adjusting allows you to program drying time according to your preferences.</p>	 <p>End: Show the stage at which the program is in progress: the program has finished.</p>
 <p>Internal lights: help to illuminate the inside of the drum.</p>	 <p>De evolutie van Smeg vaatwassers naar meer intelligente en milieuvriendelijke modellen heeft ertoe geleid om de inverter technologie te gebruiken, die een significante energie- en geluidsbesparing met zich meebrengt.</p>
 <p>Noise Level: Excellent insulation and special devices keep noise to a minimum.</p>	 <p>Eco 40-60: reference programme defined by EU regulations for measuring the energy performance of washing machines. Ideal for normally soiled cotton garments washable at 40 °C or 60 °C, it provides an excellent balance between cleaning performance and savings, although it requires a longer washing time.</p>
 <p>Program for drying cotton items including sheets, pillow cases, pajamas, lingerie, tablecloths, etc</p>	 <p>For fiber duvets indicating suitability on the label</p>
 <p>For high speed centrifuged jeans</p>	 <p>For synthetic fabrics without pigments and for cotton</p>
 <p>Short ventilation for cotton and linen garments without blowing hot air</p>	 <p>Gentle drying for shirts avoiding the formation of folds</p>
 <p>Selection of timed cycles at low temperatures.</p>	 <p>To dry wool clothes placed on a suitable basket</p>
 <p>Super fast: a programme designed to wash small amounts of laundry fast, ideal for washing lightly soiled garments.</p>	 <p>Shirts: a cycle to wash shirts in a short time with the utmost care, using a delicate spin for easy ironing.</p>
 <p>Sport: programme designed to quickly wash sports and technical clothing, which undergo frequent washes, ensuring optimal hygiene and protection of the fibres.</p>	 <p>Wool: this programme for wool or delicate fabrics uses slower rotations of the drum to ensure the utmost care for clothing.</p>



Steam Option: the steam is perfect for smoothing out creases, refreshing fabrics, neutralizing odors and releasing dirt, destroying allergens more quickly than by washing the item in water.



Shows the phase of program: Shows the phase in which the program is being.



Speciaal programma voor kledingstukken/stoffen, zoals kinderkledij, die extra onderhoud en een delicate was nodig hebben.



Het geluidsniveau wordt beperkt



Program for delicately treating garments in synthetic or mixed fabrics, such as t-shirts and blouses.



Energie-efficiëntieklasse