

# DR09EE

<b>EAN Code</b>	8017709360139
<b>Product Family</b>	Tumble dryer
<b>Commercial width</b>	60 cm
<b>Installation</b>	Free-standing
<b>Drying system</b>	Heat pump condenser
<b>Load type</b>	Frontal

















## Aesthetics

<b>Colour</b>	White	<b>Control knob colour</b>	White / Silver
<b>Front panel colour</b>	White	<b>Door colour</b>	White with silver handle
<b>LED/display colour</b>	White	<b>Door handle color</b>	Silver
<b>Function buttons colour</b>	Black	<b>Cabinet colour</b>	White

## Programs

<b>Controls</b>	<b>Electronics</b>
<b>Programme graphics</b>	Written in IT
<b>No. of programmes</b>	15
<b>Programmes</b>	

 Cotton ECO	 Rapid	 Hygiene Drying
 Outdoor/Sportswear	 Bulk/Bedding	 Cotton
 Synthetic	 Towels	 Delicates
 Refresh	 Shirts	 Jeans
 Mix	 Timed Programmes	 Duvet

## Special programmes



Hygiene Drying



Outdoor



Refresh



Shirts

## Display

Program duration

Delay start

Residual time indicator

Visualisation of the selected options

Display type



Programme progress indicator



End of cycle indicator



Clean filter indicator

Yes

Condenser container full indicator

Yes

## Technical Features



Type of motor	Standard	Transparent door	Yes
Functioning	Electronic control	Door size	40 cm
Humidity sensor	Yes	Max. door opening angle	155 °
Time drying selection	From 10 to 160 min	Door hinges	Right
Cooling down phase	Yes	Child lock (programme set lock)	Yes
Anti-iron phase	Yes	Water condenser position	At the top
Alternate drum rotation	Yes	Heating pump system	Yes
Combined filter	Yes	Type of cooling gas	R290
Fluff filter	Yes	Amount of cooling gas in kg	0.125
Drum material	Stainless steel	Condenser water drain hose	Yes
Drum volume	110 l		

## Performance / Energy label – Reg 2023



Load capacity (cotton)	9 kg	Energy efficiency class	E
Noise level for the standard cotton programme at full load	64 dB(A) re 1 pW	Weighted energy consumption in kWh per drying cycle	1.56
Time of the standard cotton program at full load	229 min	Acoustic airborne noise emission class	B
		Condensation efficiency class	C

Time of the standard cotton program at partial load

130 min

Condensation efficiency 82 %

Type

Condensing

## Electrical Connection

Connected power 900 W  
Current 10 A  
Voltage (V) 230-240 V

Frequency (Hz) 50 Hz  
Power supply cable length 150 cm  
Plug (F;E) Schuko

## Logistic Information

Width (mm) 598 mm  
Depth (mm) 608 mm

Product Height (mm) 846 mm

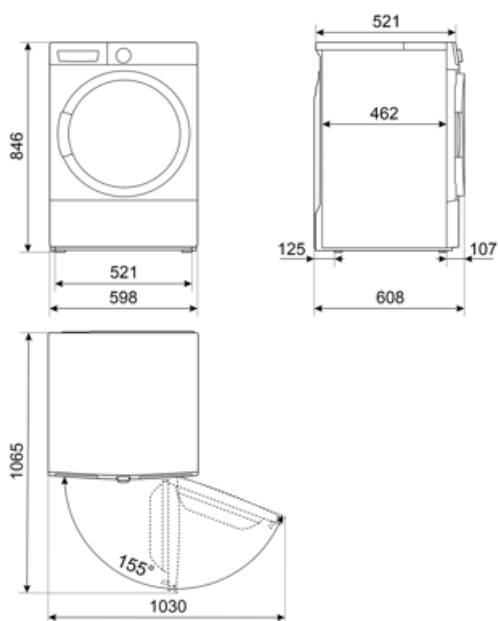

---

## Compatible Accessories

---



























### KITSPNC

Stacking kit dedicated to WN & DN  
Dimension (mm): L598xH35xP618



### KITSPNC1

## Symbols glossary

 <p>Easy Iron: this is an option which can be selected to ensure the finished laundry is left with less creases to make ironing easier.</p>	 <p>Child lock: some models are fitted with a device to lock the programme/cycle so it cannot be accidentally changed.</p>
 <p>Delay timer: can be set to run the programme at a convenient time or to take advantage of off-peak energy periods.</p>	 <p>LED display: to show programmes, functions and options selected and the time to the end of the cycle.</p>
 <p>40 cm: Large loading hatch of 40 cm in diameter, makes laundry loading and unloading easier and faster with maximum ease of use.</p>	 <p>Humidity sensor: allows to adjust dryer to obtain the desired drying level (Iron dry, Cupboard dry and Extra dry), saving time and reducing energy consumption. In addition, manual adjusting allows you to program drying time according to your preferences.</p>
 <p>End: Show the stage at which the program is in progress: the program has finished.</p>	 <p>Noise Level: Excellent insulation and special devices keep noise to a minimum.</p>
 <p>Eco 40-60: reference programme defined by EU regulations for measuring the energy performance of washing machines. Ideal for normally soiled cotton garments washable at 40 °C or 60 °C, it provides an excellent balance between cleaning performance and savings, although it requires a longer washing time.</p>	 <p>Program for drying cotton items including sheets, pillow cases, pajamas, lingerie, tablecloths, etc</p>
 <p>Delicate garments that allows the drying</p>	 <p>For fiber duvets indicating suitability on the label</p>
 <p>For high speed centrifuged jeans</p>	 <p>For synthetic fabrics without pigments and for cotton</p>
 <p>Gentle drying for shirts avoiding the formation of folds</p>	 <p>Selection of timed cycles at low temperatures.</p>
 <p>Super fast: a programme designed to wash small amounts of laundry fast, ideal for washing lightly soiled garments.</p>	 <p>Refresh: an ideal program to refresh the garments that have been kept for a long time indoors and eliminate unpleasant odors, without having to wash.</p>
 <p>Shirts: a cycle to wash shirts in a short time with the utmost care, using a delicate spin for easy ironing.</p>	 <p>Sport: programme designed to quickly wash sports and technical clothing, which undergo frequent washes, ensuring optimal hygiene and protection of the fibres.</p>
 <p>Shows the phase of program: Shows the phase in which the program is being.</p>	 <p>Special program for garments / fabrics, such as children's clothes, which require sanitized and delicate washing.</p>
 <p>Program dedicated to drying thick cotton laundry, such as towels, bathrobes, etc.</p>	 <p>This programme is suitable for outdoor clothing, waterproof jackets, jackets with inner insulation, etc. Thanks to the delicate temperature and the delicate movement of the drum, it treats the garments better to protect the external fabrics.</p>



Program for delicately treating garments in synthetic or mixed fabrics, such as t-shirts and blouses.



Energy efficiency class E