

DRC07EE

EAN Code	8017709360122
Product Family	Tumble dryer
Commercial width	60 cm
Commercial depth	Slim (46 cm)
Installation	Free-standing
Drying system	Heat pump condenser
Load type	Frontal









Aesthetics

Colour	White	Front panel type	
Front panel colour	White	Door colour	White with Silver ring
LED/display colour	White	Door handle color	White
Function buttons colour	Black	Cabinet colour	White
Control knob colour	White / Silver		

Programs

Controls	Electronics
Programme graphics	Written in IT
No. of programmes	15
Programmes	

 Cotton ECO	 Rapid	 Hygiene Drying
DownWear	 Outdoor/Sportswear	 Bulk/Bedding
 Cotton	 Synthetic	 Towels
 Refresh	 Shirts	 Daily
 Jeans	 Mix	 Timed Programmes

Special programmes



Hygiene Drying



Outdoor

Towels



Quick

Display

Time Drying

Delay start

Residual time indicator

Visualisation of the selected options

Display type



Programme progress indicator



End of cycle indicator



Clean filter indicator

Yes

Condenser container full indicator

Yes

Technical Features



Type of motor	Standard	Transparent door	Yes
Functioning	Electronic control	Door size	40 cm
Humidity sensor	Yes	Max. door opening angle	155 °
Time drying selection	From 10 to 160 min	Door hinges	Right
Cooling down phase	Yes	Child lock (programme set lock)	Yes
Anti-iron phase	Yes	Water condenser position	At the top
Alternate drum rotation	Yes	Heating pump system	Yes
Combined filter	Yes	Type of cooling gas	R290
Fluff filter	Yes	Amount of cooling gas in kg	0.115
Drum material	Stainless steel	Condenser water drain hose	Yes
Drum volume	92.5 l	Column installation, with compatible washing-machine	With stacking kit, available as optional accessory

Performance / Energy label – Reg 2023



Load capacity (cotton)	7 kg	Energy efficiency class	E
Noise level for the standard cotton programme at full load	64 dB(A) re 1 pW	Weighted energy consumption in kWh per drying cycle	1.33
		Acoustic airborne noise emission class	B

Time of the standard cotton program at full load	189 min
Time of the standard cotton program at partial load	110 min
Type	Condensing

Condensation efficiency class	C
Condensation efficiency	82 %

Electrical Connection

Connected power	900 W
Current	10 A
Voltage (V)	230-240 V

Frequency (Hz)	50 Hz
Power supply cable length	150 cm
Plug	(F;E) Schuko







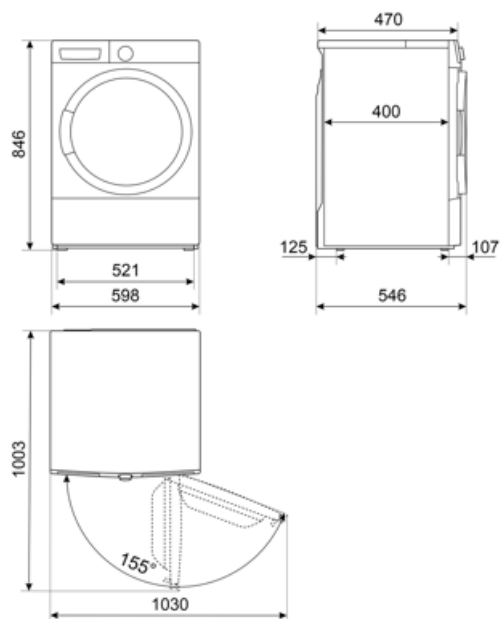

















Logistic Information

Width (mm)	598 mm
Depth (mm)	546 mm

Product Height (mm)	846 mm
---------------------	--------



Symbols glossary

	Easy Iron: this is an option which can be selected to ensure the finished laundry is left with less creases to make ironing easier.		Child lock: some models are fitted with a device to lock the programme/cycle so it cannot be accidentally changed.
	Energy efficiency class E		Delay timer: can be set to run the programme at a convenient time or to take advantage of off-peak energy periods.
	LED display: to show programmes, functions and options selected and the time to the end of the cycle.		40 cm: Large loading hatch of 40 cm in diameter, makes laundry loading and unloading easier and faster with maximum ease of use.
	This shows the amount of laundry that can be inserted into the tumble dryer in KG.		Humidity sensor: allows to adjust dryer to obtain the desired drying level (Iron dry, Cupboard dry and Extra dry), saving time and reducing energy consumption. In addition, manual adjusting allows you to program drying time according to your preferences.
	End: Show the stage at which the program is in progress: the program has finished.		Noise Level: Excellent insulation and special devices keep noise to a minimum.
	Eco 40-60: reference programme defined by EU regulations for measuring the energy performance of washing machines. Ideal for normally soiled cotton garments washable at 40 °C or 60 °C, it provides an excellent balance between cleaning performance and savings, although it requires a longer washing time.		Program for drying cotton items including sheets, pillow cases, pajamas, lingerie, tablecloths, etc
	Specific for daily drying of cotton or synthetic garments		For fiber duvets indicating suitability on the label
	For high speed centrifuged jeans		For synthetic fabrics without pigments and for cotton
	Gentle drying for shirts avoiding the formation of folds		Selection of timed cycles at low temperatures.
	Super fast: a programme designed to wash small amounts of laundry fast, ideal for washing lightly soiled garments.		Sport: programme designed to quickly wash sports and technical clothing, which undergo frequent washes, ensuring optimal hygiene and protection of the fibres.
	Shows the phase of program: Shows the phase in which the program is being.		Special program for garments / fabrics, such as children's clothes, which require sanitized and delicate washing.
	Program dedicated to drying thick cotton laundry, such as towels, bathrobes, etc.		This programme is suitable for outdoor clothing, waterproof jackets, jackets with inner insulation, etc. Thanks to the delicate temperature and the delicate movement of the drum, it treats the garments better to protect the external fabrics.



Program for delicately treating garments in synthetic or mixed fabrics, such as t-shirts and blouses.