

DUSF400S



Category	Double under-counter
Product Family	Oven
Power supply	Electric
Heat source	Electric
Heat source second cavity	Electric
Cooking method	Thermo-ventilated
Cooking Method Secondary Oven	Static
EAN code	8017709272654



Aesthetics

Aesthetics	Cucina	Serigraphy type	Symbols
Colour	Silver	Door	Full glass
Design	Flat	Handle	Squared Selection
Component finish	Stainless steel	Handle Colour	Steel effect
Material	Stainless steel	Logo	Silk screen
Type of steel	Brushed	Control knobs	Cucina restyling
Glass Type	Stopsol	Controls colour	Steel effect
Serigraphy colour	Grey		

Programs / Functions

No. of cooking functions 4
Traditional cooking functions



Ciculaire



ECO ECO



Large grill



Fan grill (large)

Programs / Functions Auxiliary Oven

No. of functions Secondary oven 4

Traditional cooking functions, cavity 2



Static



ECO



Small grill



Large grill

Controls



Display name	DigiScreen	Control setting	Knobs & touch buttons
Display technology	LED	No. of controls	4

Options



Time-setting options	Delay start and automatic end cooking	Timer	1
Minute minder	Yes	Rapid pre-heating	Yes

Options Auxiliary Oven

Time-setting options	No delay options
-----------------------------	------------------

Technical Features



Minimum Temperature	50 °C	Door	Temperate door
Maximum temperature	250 °C	Removable door	Yes
Shelf positions	4	Full glass inner door	Yes
No. of lights	1	Removable inner door	Yes
Light type	Halogen	Total no. of door glasses	3
User-replaceable light	Yes	Cooling system	Tangential
Light power	40 W	Cooling duct	Single
Grill element - power	1800 W	Speed Reduction	Yes
Circular heating element - Power	2700 W	Cooling System	
Heating suspended when door is opened	Yes	Usable cavity space dimensions (HxWxD)	316x460x412 mm
Door opening type	Standard opening	Temperature control	Electro-mechanical
		Cavity material	Easy clean enamel

Second Oven Technical Features



Minimum Temperature	80 °C	Grill element - power	1700 W
Maximum temperature	250 °C	Large grill - Power	2700 W
Shelf positions	2	Removable door	Yes
Tilting grill	Yes	Full glass inner door	Yes
No. of lights	1	Removable inner door	Yes
Light type	Halogen	No. of total door glasses	3
Light power	40 W	No. of thermoreflecting door glasses	1
Bottom heating element power	1200 W	Usable cavity space dimensions (HxWxD)	169x440x443 mm
Upper heating element - Power	1000 W		

Performance / Energy Label



Energy efficiency class	A	Number of cavities	2
Net volume of the cavity	61 litres	Energy efficiency index	95,1 %
Energy consumption in forced air convection	2.77 MJ	Energy Efficiency Index, second cavity	120 %
Energy consumption per cycle in fan-forced convection	0.77 KWh		

Performance /Energy Label - Second Cavity



Energy efficiency class, second cavity	B	Net volume of the second cavity	35 litres
Energy efficiency class, second cavity	B	Gross volume of second cavity	41 l
Energy consumption per cycle in conventional mode, second cavity	0.84 KWh	Cavity type EN 50304 second oven	small
Consumo di energia per ciclo in convezione naturale, seconda cavità	3.02 MJ		

Accessories Included

Chrome shelf	2	Grill mesh	2
Extra deep enamelled tray (40mm)	2		

Electrical Connection

Voltage	220-240 V	Voltage 2 (V)	380-415 V
Current	21 A	Frequency (Hz)	50/60 Hz

Nominal power (W) 4800 W

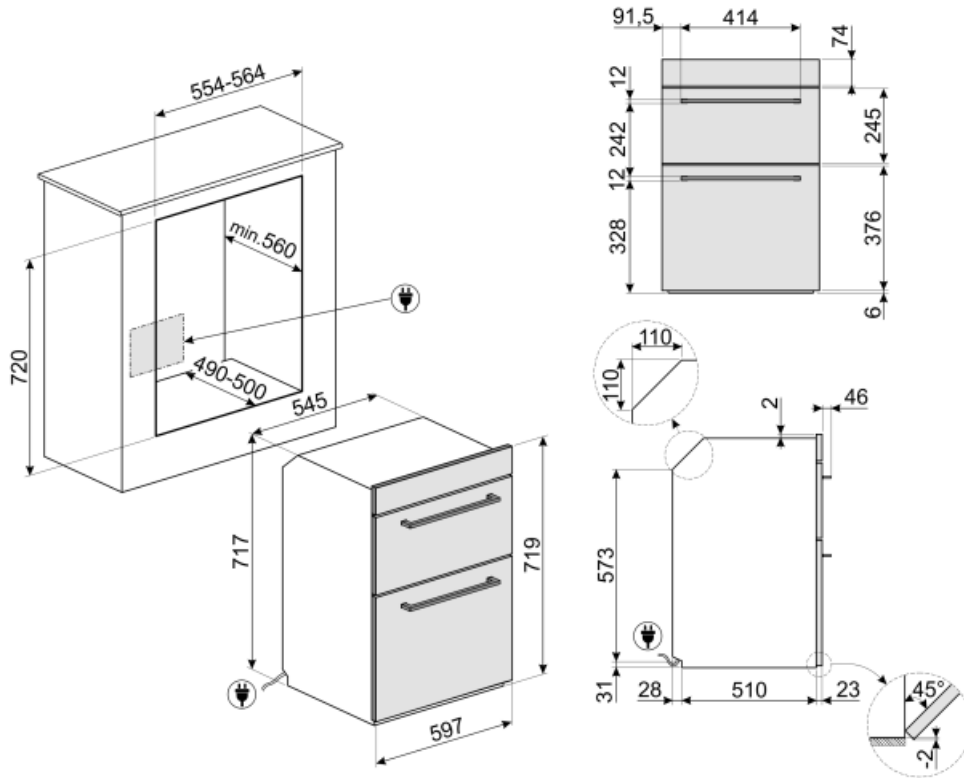

Not included accessories

GTP

Partially extractable telescopic guides (1 level) Extraction: 300 mm Material: Stainless steel AISI 430 polished

























GTT

Totally extractable telescopic guides (1 level) Extraction: 433 mm Material: Stainless steel AISI 430 polished



Symbols glossary

 <p>A: Product drying performance, measured from A+++ to D / G depending on the product family</p>	 <p>B: Product energy rating, measured from A+++ to D / G depending on the product family.</p>
 <p>Air cooling system: to ensure a safe surface temperatures.</p>	 <p>Triple glazed doors: Number of glazed doors.</p>
 <p>Electric</p>	 <p>Enamel interior: The enamel interior of all Smeg ovens have a special antacid lining which helps keep the interior clean by reducing the amount of cooking grease adhering to it.</p>
 <p>Upper and lower element only: a traditional cooking method best suited for single items located in the centre of the oven. the top pf the oven will always be hottest. Ideal for roast, fruit cakes, bread etc.</p>	 <p>Circulaire: The combination of the fan and circular element around it gives a hot air cooking method. This provides many benefits including no preheat if cook time is more than 20 minutes, no flavour transfer when cooking different foods at the same time, less energy, and shorter cook times. Good for all types of food.</p>
 <p>ECO: The combination of the grill, fan and lower element is particularly suitable for cooking small quantities of food.</p>	 <p>ECO: The combination of the grill, fan and lower element is particularly suitable for cooking small quantities of food.</p>
 <p>Grill element: Using of grill gives excellent results when cooking meat of medium and small portions, especially when combined with a rotisserie (where possible). Also ideal for cooking sausages and bacon.</p>	 <p>Half grill: For rapid cooking and browning of foods. Best results can be obtained by using the top shelf for small items, the lower shelves for larger ones, such as chops or sausages. For half grill heat is generated only at the centre of the element, so is ideal for smaller quantities.</p>
 <p>Fan with grill element: The fan reduces the fierce heat from the grill, providing an excellent method of grilling various foods, chops, steaks, sausages etc. giving even browning and heat distribution, without drying out the food. The top two levels recommended for use, and the lower part of the oven can be used to keep items warm at the same time, an excellent facility when cooking a grilled breakfast. Half grill (centre portion only) is ideal for small quantities of food.</p>	 <p>All glass inner door: All glass inner door, a single flat surface which is simple to keep clean.</p>
 <p>The inner door glass: can be removed with a few quick movements for cleaning.</p>	 <p>Side lights: Two opposing side lights increase visibility inside the oven.</p>
 <p>Rapid preheat: The rapid preheat function can be used to reach the selected temperature in just a few minutes.</p>	 <p>The oven cavity has 2 different cooking levels.</p>
 <p>The oven cavity has 4 different cooking levels.</p>	 <p>Tilting grill: the tilting grill can be easily unhooked to move the heating element and clean the roof of the appliance in one simple step.</p>
 <p>The capacity indicates the amount of usable space in the oven cavity in litres.</p>	 <p>The capacity indicates the amount of usable space in the oven cavity in litres.</p>



The capacity indicates the amount of usable space in the oven cavity in litres.



The touch timer display or DigiScreen guarantees simple functionality. They display the time, set programmed cooking and the minute minder timer.

Benefit

Rapid pre-heating

Rapid pre-heating provides a reduction in the cooking cavity heating time by up to 50%