

# DW8210X



Product Family	Dishwashers
Commercial height	82 cm
Installation	Under counter built-in
N° baskets	3, Flexi
Motor	Inverter
EAN code	8017709354749



## Programs



N. of programmes	5	Normal	Yes
Washing temperatures	45, 50, 65, 70 °F	Rinse	Yes
Auto sensor 45-65	Yes	Pots & Pans	Yes
Express 60°	Yes		

## Options



Dry Assist+ option	Yes	Intensive wash zone option	
Professional option			

## Baskets



Basket components colour	Grey	Lower Basket	With fixed racks
Upper Basket	With central fixed racks	Lower basket with anti-drip inserts	Yes
Height adjustment of the upper basket	On three levels (5 cm)	Colour Inner Components	Sage Leaf
Largest loadable dish in upper basket	25,0 inches	Cutlery basket	Yes

## Technical Features



<b>Width (mm)</b>	23 9/16 "
<b>Depth (mm)</b>	22 7/16 "
<b>Product Height (mm)</b>	32 3/16 "
<b>Programme graphics</b>	Written in EN
<b>On/off indicator</b>	Yes
<b>Rinse aid indicator</b>	Light
<b>End of cycle indicator</b>	Led on display, with acoustic signal
<b>Auto switch-off</b>	Yes
<b>Washing system</b>	Orbital
<b>Third spray arm</b>	Single
<b>Turbidity sensor Aquatest</b>	Yes
<b>Flood protection system</b>	Single Acquastop
<b>Max water hardness</b>	100°fH;58°dH

<b>Drying system</b>	Natural condenser drying, with Dry Assist + automatic door opening system at the end of the cycle
<b>Tube material</b>	Stainless steel
<b>Filter</b>	Stainless steel
<b>Concealed heating element</b>	Yes
<b>Hinges</b>	Self balancing with variable hinges
<b>Min. and max plinth height</b>	98 - 168 mm
<b>Adjustable feet</b>	7cm, from 820 to 890 mm
<b>Airborne acoustical noise emissions dBA</b>	46 dBA
<b>Additional gaskets</b>	Yes
<b>Back cover</b>	Yes
<b>Depth of dishwasher with open door (mm)</b>	1146 mm
<b>Top cover</b>	Metallic sheet

## Electrical Connection

<b>Connected power</b>	1100 W	<b>Type of connection</b>	Single-phase
<b>Current</b>	10 A	<b>Power supply cable length</b>	140 "
<b>Voltage</b>	115 V	<b>Plug</b>	(B) NEMA 5-15P
<b>Frequency (Hz)</b>	60 Hz		

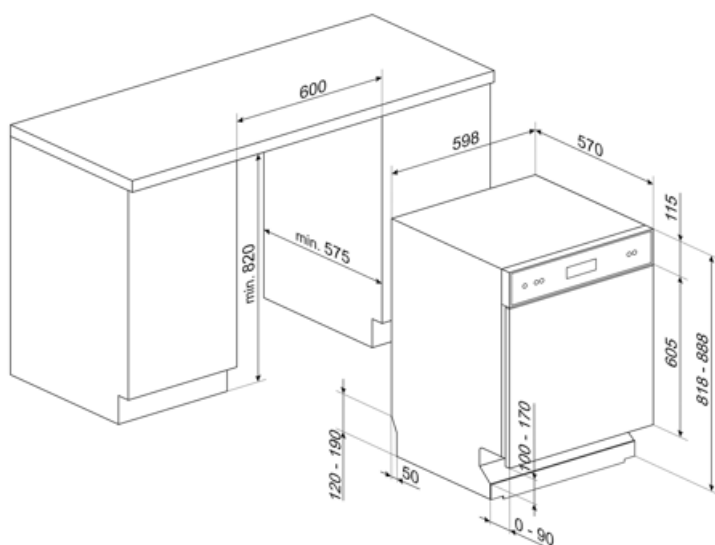

## Compatible Accessories

### KITJBDW



### KITPL60N



Toekick Kit in Black colour with adjustable height and deepness. Can be installed over all the fully integrated and underbench models with variable fulcrum or flexifit hinges.

### KITPLV2



Kit extension for dishwasher and washing machine: lenght mt. 2

### KITPL60B















Toekick Kit in White colour with adjustable height and deepness. Can be installed over all the fully integrated and underbench models with variable fulcrum or flexifit hinges.

### KITPL60X



Toekick Kit in Stainless Steel with adjustable height and deepness. Can be fitted over all the fully integrated and underbench models with variable fulcrum or flexifit hinges.

## Symbols glossary

	<p>Acquastop: Some Smeg dishwashers are equipped with a simple Acquastop: float sensor in the bottom which is necessary to prevent an accidental leakage of water inside the appliance.</p>		<p>The Aquatest sensor is an electronic sensor that measures the degree of water transparency at the end of the initial soaking phase. Based on the values measured, the sensor sets the most suitable programme, thus obtaining the best washing results with the minimum amount of water.</p>
	<p>To improve the drying of dishes without leaving stains.</p>		<p>82 cm high</p>
	<p>Smeg's evolution towards more intelligent and eco-friendly models has led to the choice of Inverter technology, which significantly reduces consumption.</p>		<p>Noise Level: Excellent insulation and special devices keep noise to a minimum.</p>
	<p>Orbital wash system distributes water evenly throughout the 60cm dishwasher cavity, directing water with precision to ensure an excellent wash.</p>		<p>Auto 45° - 65°: The auto programme regulates the length of a cycle depending on the need for a pre-wash and the number of rinses required.</p>
	<p>PRG_RINSE_72dpi</p>		<p>15 place settings: Number of place settings.</p>
	<p>System WaterSave ensures the best washing results with minimal water consumption depending on the model of dishwasher.</p>		<p>...</p>
	<p>The Dry Assist + option, in addition to saving energy, ensures perfect drying of the dishes by opening the door automatically at the end of the washing cycle.</p>		