

DW8220

Product Family	Dishwashers
Commercial height	ADA Compliant
Installation	Fully-integrated built-in
N° baskets	3, Flexi
EAN code	8017709354251



Programs



N. of programmes	10	Express 60°	Yes
Washing temperatures	30, 50, 55, 70, 75 °F	Delicate	Yes
Express 27'	Yes	Normal	Yes
Auto sensor 45-65	Yes	Rinse	Yes
Intense	Yes	Eco express	Yes
Self clean	Yes	Pots & Pans	Yes

Options



Dry Assist+ option	Yes	1/2 load FlexiZone option	Yes
Delay timer option	Up to 24 hours	Special programs option	Yes

Baskets



Basket colour	Grey	Lower basket accessories	MultiLoad
Upper Basket	With 1 foldable rack	Lower basket with anti-drip inserts	Yes
Height adjustment of the upper basket	On three levels (5 cm)	Colour Inner Components	Sage Leaf
Largest loadable dish in upper basket	25,0 inches	Cutlery basket	13 place settings sliding
Lower Basket	With 2 foldable racks		

Technical Features



Width (mm)	23 9/16 "	Flood protection system	Single Acquastop
Depth (mm)	21 7/16 "	Max water hardness	100°FH;58°dH
Display type	LED display (3 digit)	Drying system	Natural condenser drying, with Dry Assist + automatic door opening system at the end of the cycle
Product Height (mm)	32 3/16 "	Tube material	Stainless steel
Display	Delayed start, Programme time indicator	Filter	Stainless steel
On/off indicator	Yes	Concealed heating element	Yes
Salt light indicator	Light	Hinges	Self balancing, Sliding, FLEXIFIT
Rinse aid indicator	Light	Min. and max. frontal panel weight	2 - 11 lbs
Progress indicator	Yes	Min. and max plinth height	50 - 215 mm
End of cycle indicator	Acoustic signal	Adjustable feet	7cm, from 820 to 890 mm
Auto switch-off	Yes	Airborne acoustical noise emissions dBA	44 dBA
Washing system	Orbital	Additional gaskets	Yes
Third spray arm	Single	Back cover	Yes
Water softener	With electronic setting	Energy Star	Yes
Turbidity sensor Aquatest	Yes		

Electrical Connection

Connected power	1100 W	Type of connection	Single-phase
Current	13 A	Power supply cable length	140 "
Voltage	115 V	Plug	(B) NEMA 5-15P
Frequency (Hz)	60 Hz		

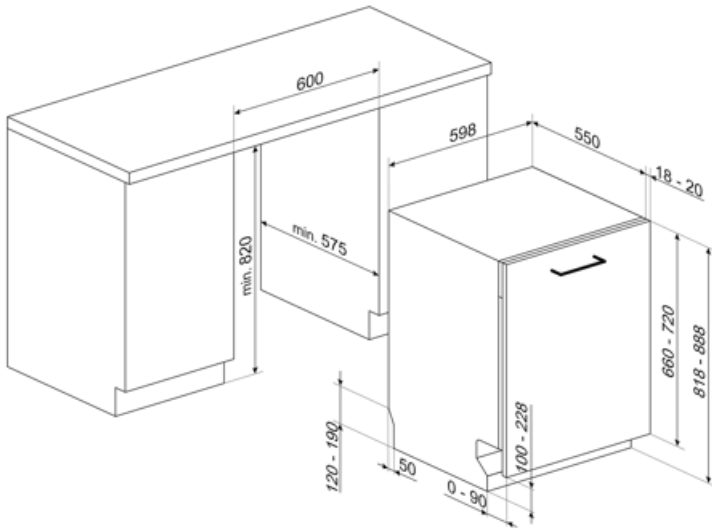

Compatible Accessories

KITFLEXI



KITPL60B

Toekick Kit in White colour with adjustable height and deepness. Can be installed over all the fully integrated and underbench models with variable fulcrum or flexifit hinges.



KITPL60X

Toekick Kit in Stainless Steel with adjustable height and deepness. Can be fitted over all the fully integrated and underbench models with variable fulcrum or flexifit hinges.



KITJBDW



KITPL60N

Toekick Kit in Black colour with adjustable height and deepness. Can be installed over all the fully integrated and underbench models with variable fulcrum or flexifit hinges.

















KITPLV2

Kit extension for dishwasher and washing machine: lenght mt. 2



Symbols glossary

	<p>Acquastop: Some Smeg dishwashers are equipped with a simple Acquastop: float sensor in the bottom which is necessary to prevent an accidental leakage of water inside the appliance.</p>		<p>The Aquatest sensor is an electronic sensor that measures the degree of water transparency at the end of the initial soaking phase. Based on the values measured, the sensor sets the most suitable programme, thus obtaining the best washing results with the minimum amount of water.</p>
	<p>To improve the drying of dishes without leaving stains.</p>		<p>Delay Timer: Option to postpone the start of the desired programme by up to 24 hours in order to programme the dishwasher to run at the desired time.</p>
	<p>The Dry Assist + option, in addition to saving energy, ensures perfect drying of the dishes by opening the door automatically at the end of the washing cycle.</p>		<p>The FlexiFit hinges allow the kitchen panel to slide over the dishwasher door, allowing a minimum kitchen plinth height of 5 cm.</p>
	<p>FlexiZone: The ½ load flexizone allows you to wash a reduced load saving energy, water and time and there are no restrictions on where the items are placed.</p>		<p>Smeg's evolution towards more intelligent and eco-friendly models has led to the choice of Inverter technology, which significantly reduces consumption.</p>
	<p>Noise Level: Excellent insulation and special devices keep noise to a minimum.</p>		<p>Orbital wash system distributes water evenly throughout the 60cm dishwasher cavity, directing water with precision to ensure an excellent wash.</p>
	<p>Auto 45°- 65°: The auto programme regulates the length of a cycle depending on the need for a pre-wash and the number of rinses required.</p>		<p>Delicate: Delicate washing program is designed for delicate dishes which are not heavily soiled.</p>
	<p>PRG_RINSE_72dpi</p>		<p>Express 27': The Express 27' programme is a quick wash cycle, at low temperatures, for lightly soiled dishes.</p>
	<p>Ultraclean: The Ultraclean option performs a final rinse at a high temperature of 70°C eliminating virtually all bacteria.</p>		<p>15 place settings: Number of place settings.</p>
	<p>System WaterSave ensures the best washing results with minimal water consumption depending on the model of dishwasher.</p>		<p>...</p>
	<p>Dishwasher cleaning cycle. The cycle should be started with the machine empty, without dishes. It is recommended to run the program every 2-3 months, using special dishwasher detergents.</p>		<p>SILENT: Wash cycle suitable for normally soiled dishes, even with dried-on residues. Ensures maximum noise reduction and is therefore ideal if you wish to run it during the night.</p>
	<p>Allows you to enable additional programs when selected together with any wash cycle.</p>		