

DW8220



Product family	Dishwashers
Width	24"
Commercial height	82 cm
N° baskets	3, Flexi
EAN code	8017709354251

Programs



Number of programs	10	Express 60°	Si
Washing temperatures	30, 50, 55, 70, 75 °F	Delicates	Yes
Express 27'	Yes	Normal	Yes
Automatic	Yes	Rinse	Yes
Intense	Yes	Eco express	Yes
Self Clean	Yes	Pots & Pans	Yes

Options



Dry Assist+ option	Yes	Intensive washing zone option	
Delay start	Up to 24 hours	Special programs option	Yes
FlexiZone half-load option	Yes		

Baskets



Basket color	Gray	Lower basket accessories	MultiLoad
Upper basket	1 foldable rack	Lower basket with anti-drip inserts	Yes
Upper basket height adjustment	On 3 levels	Colour Inner Components	Sage Leaf
Largest loadable dish in upper basket	25,0 inches		
Lower basket	With 2 foldable racks		

Cutlery basket

13 place settings

Technical Features

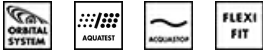

Width	23 9/16 "
Depth	21 7/16 "
Display type	LED display (3 digits)
Height	32 3/16 "
Display	Delay start, Program progress indicator
On/off indicator	Yes
Salt indicator	Light
Rinse aid indicator	Light
Program progress indicator	Yes
End-of-cycle indicator	Acoustic signal
Washing system	Orbital
Third spray arm	Single
Water softener	With electronic setting

Turbidity sensor	Yes
Aquatest	
Flood protection system	Single Aquastop
Max water hardness	100°FH;58°dH
Drying system	Natural condenser drying, with Dry Assist + automatic door opening system at the end of the cycle
Tube material	Stainless steel
Filter	Stainless steel
Concealed heating element	Yes
Hinges	Self-balancing, Sliding, FLEXIFIT
Min. and max. frontal panel weight	4.4 - 24.3 lbs
Min. and max plinth height	50 - 215 mm
Adjustable feet	2 3/4", from 32 1/4" to 35"
Additional gaskets	Yes
Back cover	Yes

Electrical Connection

Plug	(A) USA & Mexico	Frequency (Hz)	60 Hz
Connected power	1100 W	Connection type	Single-phase
Current	13 A	Power supply cable length	140 "
Voltage	115 V		

Compatible Accessories



KIT82CX

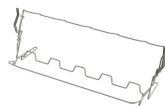

KITGH

Kit glass holder. It has to be fitted on the first basket but only if there are foldable racks



KITPL60B

Toekick Kit in White colour with adjustable height and deepness. Can be installed over all the fully integrated and underbench models with variable fulcrum or flexifit hinges.



KITPL60N

Toekick Kit in Black colour with adjustable height and deepness. Can be installed over all the fully integrated and underbench models with variable fulcrum or flexifit hinges.

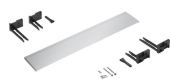

KITPL60X























Toekick Kit in Stainless Steel with adjustable height and deepness. Can be fitted over all the fully integrated and underbench models with variable fulcrum or flexifit hinges.



KITPLV2

Kit extension for dishwasher and washing machine: lenght mt. 2

Symbols glossary

	Acquastop: Some Smeg dishwashers are equipped with a simple Acquastop: float sensor in the bottom which is necessary to prevent an accidental leakage of water inside the appliance.		Aquatest measures the clarity of the water during an auto program, and automatically ensures the minimum consumption of water and energy.
	Anti-drip: Some models of dishwashers are equipped with special polymer nozzles anti-drip, that improve the process of drying.		COMM_HEIGHT_82_72dpi
	Delay Timer: The delay timer can postpone the start of the program by up to 24 hours.		Models with new Flexi Fit hinges are able to be installed in kitchens with a plinth of just 5cms. With this new hinge design, the panel has a sliding movement from the bottom to the top, avoiding any possible interference of the panel with the plinth.
	FlexiZone: The ½ load flexizone allows you to wash a reduced load saving energy, water and time and there are no restrictions on where the items are placed.		Inverter technology: The evolution of Smeg's driers towards more intelligent and environmentally sustainable models has led to the choice of using Inverter technology with heat pumps, which reduces significantly energy consumption.
	Noise Level: Excellent insulation and special devices keep noise to a minimum.		Orbital wash system distributes water evenly throughout the 60cm dishwasher cavity, directing water with precision to ensure an excellent wash.
	Auto 45°- 65°: The auto programme regulates the length of a cycle depending on the need for a pre-wash and the number of rinses required.		Delicate: Delicate washing program is designed for delicate dishes which are not heavily soiled.
	PRG_RINSE_72dpi		Rapid 27 Mins: The rapid 27 mins quick program takes just 27 minutes to wash a load.
	Ultraclean: The Ultraclean option performs a final rinse at a high temperature of 70°C eliminating virtually all bacteria.		The symbols show the number of plate settings of the dishwasher.
	System WaterSave ensures the best washing results with minimal water consumption depending on the model of dishwasher.		...
	...		...
	...		The Dry Assist + option, in addition to saving energy, ensures perfect drying of the dishes by opening the door automatically at the end of the wash c

Benefit (TT)

Orbital Wash System

Even water distribution, deep cleaning and low noise thanks to the dual rotating spray arms

Orbital washing system, which, thanks to its double arm, its 7 water exit points and thanks to overlapping and simultaneous rotations and 40 rotations per minute, allows ample coverage of the tank area, thus guaranteeing optimal results in any basket-loading configuration.

Flexifit hinge system

Smooth-running door for optimal integration into the kitchen design

The height of the plinth can vary from 5 cm to 21.5 cm, allowing it to fit perfectly into the cabinet.

Thanks to this solution, the dishwasher blends harmoniously into its surroundings, with the door and plinth perfectly aligned with the other kitchen furniture.

DryAssist+

The Dry Assist+ system of automatic door opening at the end of the cycle ensures fast and energy-efficient drying