

# DW8601X

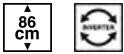

Product family	Dishwashers
Commercial height	86 cm
Installation	Under-Counter
Kitchen panel	Not supplied
N° baskets	2
Engine	Inverter
EAN code	8017709363451
UPC Code	812895027747



## Programs



Number of programs	8	Super	Yes
Washing temperatures	45, 50, 55, 65 °F	Regular	Yes
Light soiling	Yes	Intensive 150°F	Yes
Delicates	Yes	Intensive 160°F	
Auto	Yes	Rinse	Yes

## Options

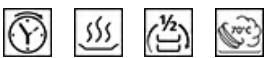

Hi-Temp	Yes	Delay start	Up to 24 hours
Extra Fast	Yes	Extra-dry option	Yes
Sanitize	Yes	FlexiZone half-load option	Yes
Silent	Yes	Hyclean sanitizing option	Yes

## Baskets

Basket color	Gray	Upper basket height adjustment	On two levels (5cm)
Basket components finish	Gray	Lower basket	With 4 foldable racks
Handle	In plastic on upper and lower basket	Colour Inner Components	Gray
Upper basket	With 2 foldable racks	Cutlery basket	Yes

## Technical Features









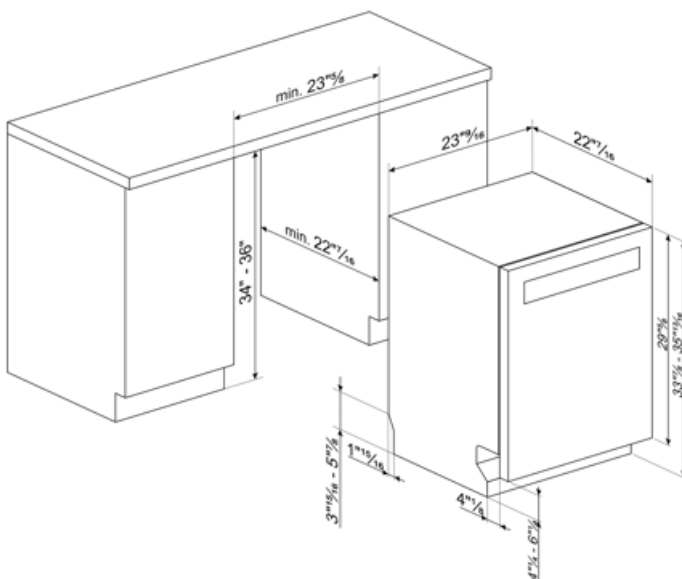









<b>Width</b>	23 9/16 "	<b>Washing system</b>	Standard
<b>Depth</b>	22 7/16 "	<b>Turbidity sensor Aquatest</b>	Yes
<b>Display type</b>	LED display (3 digits)	<b>Flood protection system</b>	Single Acquastop
<b>Height</b>	33 7/8 "	<b>Drying system</b>	Natural condensation drying
<b>Controls</b>	Electronic	<b>Tube material</b>	Stainless steel
<b>Display</b>	Delay start, Program progress indicator	<b>Filter</b>	Stainless steel
<b>Program symbols</b>	Writings in English	<b>Concealed heating element</b>	Yes
<b>On/off indicator</b>	Yes	<b>Can be installed in-column</b>	Yes
<b>Rinse aid indicator</b>	Light	<b>Adjustable feet</b>	2", from 32 1/4" to 34 1/4"
<b>End-of-cycle indicator</b>	On display, with acoustic signal	<b>Back feet adjustable from front</b>	Yes

## Electrical Connection

<b>Connected power</b>	1400 W	<b>Connection type</b>	Single-phase
<b>Current</b>	12 A	<b>Power supply cable length</b>	116 "
<b>Voltage</b>	120 V	<b>Plug</b>	(B) NEMA 5-15P
<b>Frequency (Hz)</b>	60 Hz		



## Symbols glossary

 <p>Acquastop: Some Smeg dishwashers are equipped with a simple Acquastop: float sensor in the bottom which is necessary to prevent an accidental leakage of water inside the appliance.</p>	 <p>Aquatest measures the clarity of the water during an auto program, and automatically ensures the minimum consumption of water and energy.</p>
 <p>Installation in column: Installation in column</p>	 <p>COMM_HEIGHT_86_72dpi</p>
 <p>Delay Timer: The delay timer can postpone the start of the program by up to 24 hours.</p>	 <p>FlexiZone: The ½ load flexizone allows you to wash a reduced load saving energy, water and time and there are no restrictions on where the items are placed.</p>
 <p>Hyclean: When the HYCLEAN option is selected, the dishwasher performs a final 10 minute rinse at a high temperature of 70°C, eliminating virtually all bacteria to achieve the highest possible standards of cleanliness. The Hyclean option can be selected with almost all cycles at temperatures above 50°C.</p>	 <p>Inverter technology: The evolution of Smeg's driers towards more intelligent and environmentally sustainable models has led to the choice of using Inverter technology with heat pumps, which reduces significantly energy consumption.</p>
 <p>Noise Level: Excellent insulation and special devices keep noise to a minimum.</p>	 <p>Delicate: Delicate washing program is designed for delicate dishes which are not heavily soiled.</p>
 <p>Delicate: Delicate washing program is designed for delicate dishes which are not heavily soiled.</p>	 <p>PRG_RINSE_72dpi</p>
 <p>PRG_STRONG_72dpi</p>	 <p>The symbols show the number of plate settings of the dishwasher.</p>
 <p>EXTRA DRY This option adds a hot rinse cycle that ensures improved drying.</p>	 <p>The Regular programme is for dishes with regular dirt, even with dried-on residues.</p>
 <p>LIGHT SOILING Washing programme with low water and energy consumption.</p>	