

DWA6214W2

Product Family	Dishwashers
Commercial width	60 cm
Commercial height	85 cm
Installation	Free-standing
N° baskets	2
EAN code	8017709278823



Programs



N. of programmes	5	Ultraclean	Yes
Washing temperatures	45, 55, 65, 70 °C	Intensive 65°	Yes
Soak	Yes	Normal ECO	Yes
ECO	Yes		

Options



Delay timer option	3-6-9 hours	Options for tabs FlexiTabs	Yes
--------------------	-------------	----------------------------	-----

Baskets



Basket colour	Grey	Lower Basket	With 2 foldable racks
Basket components colour	Grey	Lower basket with anti-drip inserts	Yes
Handle	In plastic on upper and lower basket	Largest loadable dish in lower basket	30,0 cm
Upper Basket	With central fixed racks	Colour Inner Components	Grey handles, Grey pastic plate for regulation second basket on three levels, Green Orbital
Height adjustment of the upper basket	On three levels	Cutlery basket	13 place settings sliding
Largest loadable dish in upper basket	25,0 cm		

Technical Features



Width (mm)	598 mm
Depth (mm)	600 mm
Product Height (mm)	848 mm
Controls	Electronic
Programme graphics	Symbols
On/off indicator	Yes
Rinse aid indicator	Light
End of cycle indicator	Led on display, with acoustic signal
Washing system	Orbital
Third spray arm	Single
Flood protection system	Total Acquastop

Water supply	Single; cold/hot water max. 60°C - energysave with hot water up to 35%
Max water hardness	100°fH;58°dH
Drying system	Natural condenser drying
Tube material	Stainless steel
Filter	Stainless steel
Concealed heating element	Yes
Hinges	Self balancing with fixed hinges
Adjustable feet	Just for levelling
Back cover	Yes, with covered counterweight
Depth of dishwasher with open door (mm)	1168 mm
Removable top	Yes, with optional KIT

Electrical Connection

Connected power	1800 W	Type of connection	Single-phase
Current	10 A	Power supply cable length	140 cm
Voltage	220-240 V	Plug	(I) Australia
Frequency (Hz)	50 Hz		

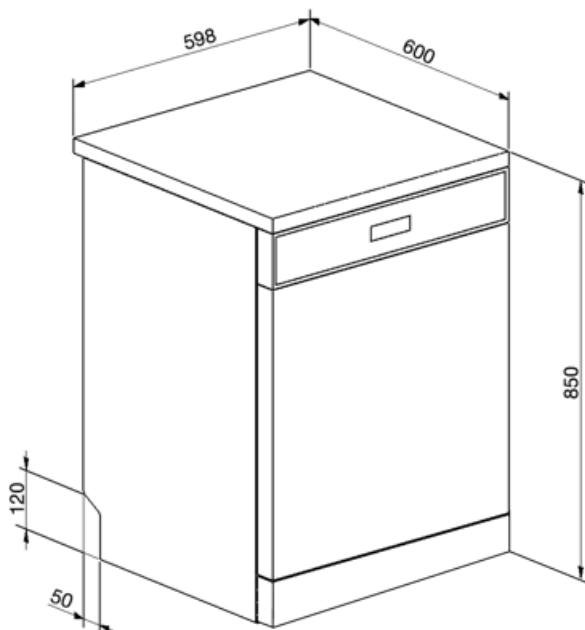

Compatible Accessories

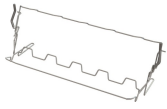

KITGH

Kit glass holder. It has to be fitted on the first basket but only if there are foldable racks

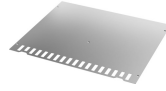

KITINC











a steel bar fitted on the top will block the dishwasher at the top.



KITPLV2

Kit extension for dishwasher and washing machine: lenght mt. 2

Symbols glossary

-  Anti-drip: Some models of dishwashers are equipped with special polymer nozzles anti-drip, that improve the process of drying.
-  Flexitabs: Flexitabs adjusts the wash cycle to give the best possible results regardless of the type of detergent used.
-  Orbital wash system distributes water evenly throughout the 60cm dishwasher cavity, directing water with precision to ensure an excellent wash.
-  Soak programme: The soak programme provides a rinse to prevent dirt from drying.
-  The symbols show the number of plate settings of the dishwasher.
-  System WaterSave ensures the best washing results with minimal water consumption depending on the model of dishwasher.
-  Delay Timer: The delay timer can postpone the start of the program by up to 24 hours.
-  Noise Level: Excellent insulation and special devices keep noise to a minimum.
-  Eco: Eco, this economic wash programme uses a low amount of water and energy in order to provide the most environmentally friendly cleaning option.
-  REF_PRG_NORMAL_ECO_72dpi
-  Total Acquastop: In addition to the partial Acquastop protection present in all Smeg dishwashers, some models have an electronic device fitted to the water intake hose, which monitors water levels in the machine, detects leaks in the hose and switches off the water supply immediately when necessary.