

DWA6314B

Familie	Vaatwasser
Commerciële breedte	60 cm
Nishoogte	85 cm
Installatie	Vrijstaand
Aantal korven	3, Flexi
Motor	Eenfasig
EAN-code	8017709217587

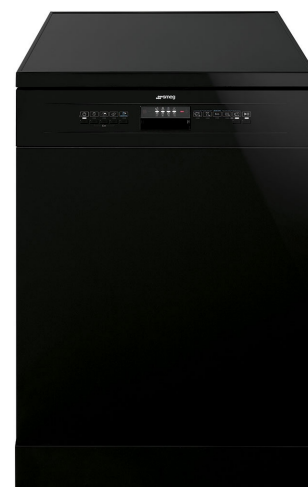

Programs



Aantal programma's	5 standaard + 4 Quick Time programma's	ECO Quick	Ja
Wastemperatuur	38, 45, 50, 65, 70 °C	Delicate vaat, snel	Ja
Weken	Ja	Dagelijks snel	Ja
Snel 27'	Ja	Sterk en snel	Ja
Eco	Ja	Intensief 65°	Ja
Ultraclean	Ja	Normaal ECO	Ja

Opties

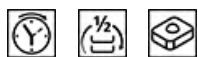

Delay timer optie	3-6-9-12 uur, i.c.m. automatisch spoelen	FlexiTabs optie	Ja
FlexiZone ½ (halve beladingsmogelijkheid)	Ja	Quick Time option	Ja

Korven



Kleur korven	Grijs	Maximum afmetingen bord dat in bovenste korf kan worden geladen	23,5 cm
Kleur korfcomponenten	Grijs	Onderkorf	Met 4 opvouwbare rekken
Handgreep	Van kunststof met roestvrijstalen inzet op boven- en onderrek		
Bovenkorf	Met vaste rekken		

In hoogte verstelbare bovenkorf	3 niveaus	Onderkorf met anti-drup inserts	Ja
		Maximum afmetingen bord dat in onderste korf kan worden geladen	30,0 cm
		Bestekmandje	13 couverts, schuivend

Technische specificaties



Breedte product	598 mm	Watertoevoer	Enkel; koud en warm water tot 60°C - energiebesparing tot 35%
Diepte product	600 mm	Maximale waterhardheid	100°FH;58°dH
Hoogte product	848 mm	Droogstelsysteem	Natuurlijke condensatie
Bediening	Elektronisch	Kinderbeveiliging	Ja
Display	Instelling Delay timer	Materiaal kuip	Roestvrij staal
Grafische weergave programma's	Symbolen	Filter	Roestvrij staal
Aan/uit indicator	Ja	Verborgen verwarmingselement	Ja
Glansspoelmiddel indicator	Indicator (lampje)	Scharnieren	Zelfbalancerend met vast steunpunt
Indicator voortgang programma	Ja	Verstelbare voetjes	Alleen voor niveau aanpassing
Indicator einde cyclus	Indicator (lampje), met akoestisch alarm	Geluidsisolatie niveau	Medium
Wassysteem	Orbital	Back cover	Yes, with covered counterweight
Derde sproeiarm	Enkel	Diepte vaatwasser met open deur (mm)	1168
Overstroombeveiliging	Total Acquastop	Verwijderbare bovenkant	Ja, met optionele KIT

Elektrische aansluiting

Stekker	(I) Australia	Frequentie	50 Hz
Aansluitwaarde	1800 W	Type aansluiting	Single-phase
Stroom	10 A	Lengte voedingskabel	140 cm
Spanning	220-240 V		

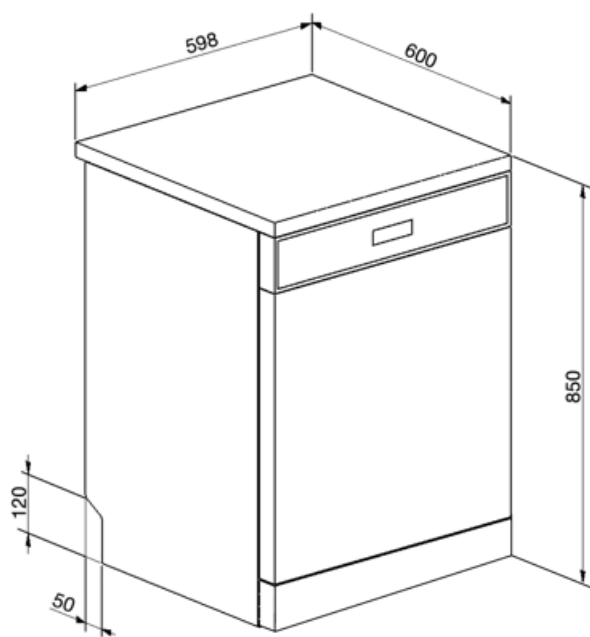

Accessoires niet inbegrepen

KITGH

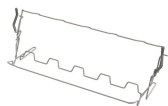

Kit glazen houder. Deze moet op de eerste mand worden gemonteerd, maar alleen als er inklapbare rekken zijn

KITINC

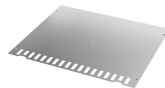















KITPLV2



Kit verlengstuk voor vaatwasser en wasmachine: lengte 2 mtr.

Symbols glossary (TT)

 To improve the drying of dishes without leaving stains.	 Kinderslot: sommige modellen zijn voorzien van een apparaat om het programma / de cyclus te vergrendelen zodat het niet kan per ongeluk veranderd
 Vertragingstimer: De uitgestelde timer kan de start van het programma tot 24 uur uitstellen.	 Ideal for multi-function detergents, this option allows washing to be optimised, with full benefits from the combined-action tablets. When this option is activated, any salt and rinse aid is used.
 FlexiZone: The 1/2 load flexizone allows you to wash a reduced load saving energy, water and time and there are no restrictions on where the items are placed.	 Noise Level: Excellent insulation and special devices keep noise to a minimum.
 Orbital wash system distributes water evenly throughout the 60cm dishwasher cavity, directing water with precision to ensure an excellent wash.	 Daily Quick: The daily program is suitable for quick daily washing of dishes.
 Delicate Quick: Program Delicate Quick is suitable for quick washing of delicate dishes.	 Eco: Eco, this economic wash programme uses a low amount of water and energy in order to provide the most environmentally friendly cleaning option.
 Eco: Eco, this economic wash programme uses a low amount of water and energy in order to provide the most environmentally friendly cleaning option.	 Soak programme: The soak programme provides a rinse to prevent dirt from drying.
 Strong&Fast: This special programme takes less than 1 hour to eliminate the most stubborn dirt and dried on residues.	 REF_PRG_NORMAL_ECO_72dpi.jpg
 14 place settings: Number of place settings.	 Total Acquastop: In addition to the partial Acquastop protection present in all Smeg dishwashers, some models have an electronic device fitted to the water intake hose, which monitors water levels in the machine, detects leaks in the hose and switches off the water supply immediately when necessary.
 System WaterSave ensures the best washing results with minimal water consumption depending on the model of dishwasher.	