

DWAFI6D15T



Familie	Vaatwasser
Commerciële breedte	60 cm
Nishoogte	Maxi, 86 cm
Installatie	Volledig geïntegreerd
Deur paneel	Niet meegeleverd
Aantal korven	3, FlexiDuo
Motor	Eenfasig
EAN-code	8017709220037



Programs



Aantal programma's	5 standaard + 4 Quick Time programma's	ECO Quick	Ja
Wastemperatuur	38, 45, 50, 65, 70 °C	Dagelijks snel	Ja
Weken	Ja	Normaal snel	Ja
Snel 27'	Ja	Auto 60-70	Ja
Eco	Ja	Sterk en snel	Ja
Ultraclean	Ja	Normaal ECO	Ja

Opties

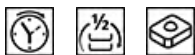

EnerSave optie	Ja	FlexiTabs optie	Ja
Delay timer optie	Tot 24 uur, i.c.m. automatisch spoelen	Quick Time option	Ja
FlexiZone ½ (halve beladingsmogelijkheid)	Ja		

Korven



Kleur korven	Grijs	Maximum afmetingen bord dat in bovenste korf kan worden geladen	18,0 cm
Kleur korfcomponenten	Grijs		

Handgreep	Van kunststof met roestvrijstalen inzet op boven- en onderrek	Onderkorf	Met inklapbare rekken en glazenhouder
Bovenkorf	Met inklapbare centrale rekken en glazenhouder	Onderkorf met anti-drup inserts	Ja
In hoogte verstelbare bovenkorf	3 niveaus	Maximum afmetingen bord dat in onderste korf kan worden geladen	35,0 cm
Bovenmand met EasyGlide System:	Ja	Bestekmandje	13 couverts, schuivend

Technische specificaties



Breedte product	598 mm	Maximale waterhardheid	100°fH;58°dH
Diepte product	550 mm	Droogsysteem	Natural condenser drying, with EnerSave automatic door opening system at the end of the cycle
Type display	3 cijfers	Stoombeveiliging	Van kunststof
Hoogte product	858 mm	Binnenverlichting	With White led
Bediening	Elektronisch	Materiaal kuip	Roestvrij staal
Display	Instelling Delay timer	Filter	Roestvrij staal
Grafische weergave programma's	Symbolen	Verborgen verwarmingselement	Ja
Zout indicator	Indicator (lampje)	Scharnieren	Zelfbalancerend met variabel steunpunt
Glansspoelmiddel indicator	Indicator (lampje)	Min. en max. frontaal paneelgewicht	2 - 8 kg
Indicator voortgang programma	Ja	Min. en max plinthoogte	100 - 228 mm
Indicator einde cyclus	ActiveLight	Verstelbare voetjes	7 cm, van 860 tot 930 mm
Wassysteem	Planetarium	Geluidsisolatie niveau	Top
Derde sproeiarm	Enkel	Extra pakkingen	Ja, met roestvrijstalen plaat
Waterontkalker	Elektronisch instelbaar	Back cover	Ja
Aquatest sensor	Ja	Diepte vaatwasser met open deur (mm)	1146
Overstroombeveiliging	Total Acquastop	Voetjes achterzijde vanaf de voorkant regelbaar	Ja
Watertoevoer	Enkel; koud en warm water tot 60°C - energiebesparing tot 35%		

Elektrische aansluiting

Stekker	(I) Australia	Frequentie	50 Hz
Aansluitwaarde	1800 W	Type aansluiting	Single-phase
Stroom	10 A	Lengte voedingskabel	140 cm
Spanning	220-240 V		

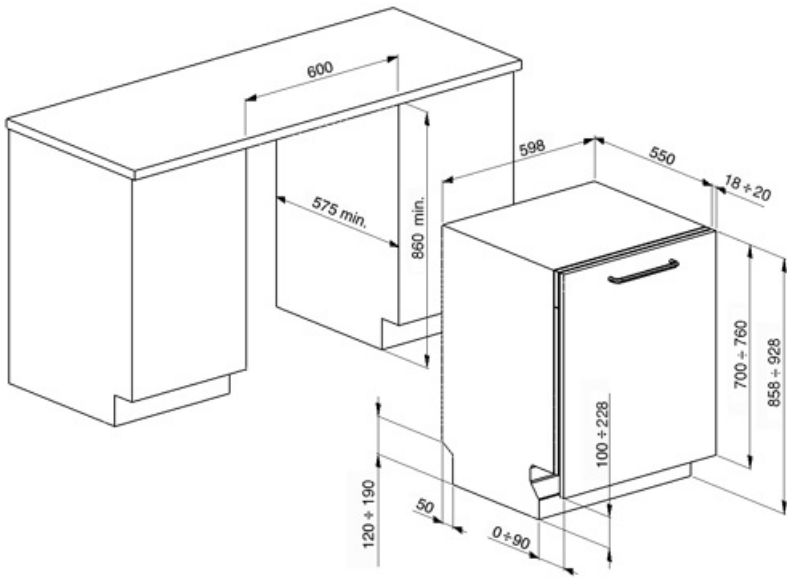

Compatibele Accessoires



KIT86VX

stainless steel panel with Victoria handle. Can be fitted on the fully integrated dishwashers H86 with no Flexifit hinges. It is not possible to install it on the models with stainless steel panel

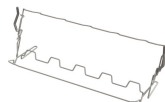

KITGH

Kit glazen houder. Deze moet op de eerste mand worden gemonteerd, maar alleen als er inklapbare rekken zijn



KITPL60B

Toekick Kit in witte kleur met verstelbare hoogte en diepte. Kan worden geïnstalleerd over alle volledig geïntegreerde modellen en modellen onderbouw met variabel draaipunt of flexifit-scharnieren.



KITPL60N

Toekick Kit in zwarte kleur met verstelbare hoogte en diepte. Kan worden geïnstalleerd over alle volledig geïntegreerde modellen en onderbouw modellen met variabel draaipunt of flexifit-scharnieren.



KITPL60X























Toekick Kit in roestvrij staal met verstelbare hoogte en diepte. Kan worden gemonteerd over alle volledig geïntegreerde modellen en onderbouw modellen met variabel draaipunt of flexifit-scharnieren.



KITPLV2

Kit verlengstuk voor vaatwasser en wasmachine: lengte 2 mtr.

Symbols glossary

	<p>Activelight is een led die een rode stip projecteert op de vloer onder de vaatwasser als het apparaat in gebruik is</p>		<p>Aquatest meet de helderheid van het water tijdens een automatisch programma en zorgt automatisch voor een minimaal verbruik van water en energie</p>
	<p>To improve the drying of dishes without leaving stains.</p>		<p>86 cm high</p>
	<p>Vertragingstimer: De uitgestelde timer kan de start van het programma tot 24 uur uitstellen.</p>		<p>EasyGlide: handig EasyGlide-systeem voor eenvoudig uitladen van het apparaat en dat maximale flexibiliteit van het laden van de machine mogelijk maakt</p>
	<p>FlexiDuo: The FlexiDuo 3rd cutlery basket allows you to arrange cutlery or small cups, ladles, or bulky utensils however you like: it consists of two separate and moveable modules.</p>		<p>Ideal for multi-function detergents, this option allows washing to be optimised, with full benefits from the combined-action tablets. When this option is activated, any salt and rinse aid is used.</p>
	<p>FlexiZone: The ½ load flexizone allows you to wash a reduced load saving energy, water and time and there are no restrictions on where the items are placed.</p>		<p>Noise Level: Excellent insulation and special devices keep noise to a minimum.</p>
	<p>The Planetarium washing system, with high rotations per minute, guarantees complete coverage of the tank, thanks to the simultaneous rotation of base and sprayers, and excellent washing results.</p>		<p>Auto 60° - 70°: The auto program regulates the length of a cycle depending on the need for a pre-wash and the number of rinses required.</p>
	<p>Daily Quick: The daily program is suitable for quick daily washing of dishes.</p>		<p>Eco: Eco, this economic wash programme uses a low amount of water and energy in order to provide the most environmentally friendly cleaning option.</p>
	<p>Eco: Eco, this economic wash programme uses a low amount of water and energy in order to provide the most environmentally friendly cleaning option.</p>		<p>Normal Quick: Program Normal Quick is suitable for quick washing of mixed dishes, for everyday use.</p>
	<p>Soak programme: The soak programme provides a rinse to prevent dirt from drying.</p>		<p>Strong&Fast: This special programme takes less than 1 hour to eliminate the most stubborn dirt and dried on residues.</p>
	<p>REF_PRG_NORMAL_ECO_72dpi.jpg</p>		<p>15 place settings: Number of place settings.</p>
	<p>Total Acquastop: In addition to the partial Acquastop protection present in all Smeg dishwashers, some models have an electronic device fitted to the water intake hose, which monitors water levels in the machine, detects leaks in the hose and switches off the water supply immediately when necessary.</p>		<p>System WaterSave ensures the best washing results with minimal water consumption depending on the model of dishwasher.</p>

Benefit (TT)

Active Light

Maximum control thanks to the light projected on the floor that indicates when the dishwasher is running and when the cycle is complete

Smeg dishwashers equipped with ActiveLight signal the appliance's activity status by projecting a light on the floor while the cycle is running. The light goes out at the end of the cycle, signalling that the dishwasher can be unloaded.

FlexiDuo

The flexible third basket provides additional space, adapting to the load to accommodate various types of dishes, ensuring optimal organization and efficient use of interior capacity

The third FlexiDuo basket consists of two separate sections that can be handled independently of each other, stacked and/or removed, offering loading flexibility for every need. Depending on the arrangement, it allows cups, tall glasses, bulky utensils and pots and pans to be placed in the upper basket.

Planetarium Wash System

Full and deep wash coverage thanks to the advanced movement of the spray arm, an innovation patented by Smeg

Smeg's patented Planetarium Wash System guarantees impeccable cleaning. With a simultaneous double movement of the sprayer and 65 rotations per minute, it reaches every nook and cranny for extraordinary results. Dishes, glasses and utensils will be perfectly clean in no time. An intelligent system where efficiency and style meet, delivering brilliant results effortlessly.