

DWAFI6D15T3



Product Family	Dishwashers
Commercial width	60 cm
Commercial height	86 cm
Installation	Fully-integrated built-in
Kitchen panel	Not supplied
N° baskets	3, FlexiDuo
Motor	Inverter
EAN code	8017709297138



Programs / Functions



N. of programmes	10	Auto sensor 45-65	Yes
Washing temperatures	38, 45, 50, 55, 65, 70, 75 °C	Quiet (~2 dB)	Yes
Soak	Yes	Intense	Yes
Express 27'	Yes	Sterilise	Yes
Crystal	Yes	Regular	Yes
Full express - 60 minutes	Si	Normal ECO	Yes

Options



Dry Assist+ option	Yes	Options for tabs	Yes
Delay timer option	Up to 24 hours	FlexiTabs	
1/2 load FlexiZone option	Yes	Special programs option	Si

Baskets



Basket colour	Grey	Largest loadable dish in upper basket	19,0 cm
Basket components colour	Grey	Lower Basket	With completely foldable racks and glass holder

Handle	In plastic with stainless steel insert on upper and lower basket	Lower basket with anti-drip inserts	Yes
Upper Basket	With 3 foldable racks	Largest loadable dish in lower basket	35,0 cm
Height adjustment of the upper basket	On three levels	Colour Inner Components	Blue
Sliding Guides Extra Glide	Yes	Cutlery basket	13 place settings sliding

Technical Features



Width (mm)	598 mm	Max water hardness	100°fH;58°dH
Depth (mm)	550 mm	Drying system	Natural condenser drying, with Dry Assist + automatic door opening system at the end of the cycle
Display type	LED display	Steam protection	In plastic
Product Height (mm)	858 mm	Internal light	With White led
Controls	Electronic	Tube material	Stainless steel
Display	Delayed start	Filter	Stainless steel
Programme graphics	Symbols	Concealed heating element	Yes
Salt light indicator	Light	Hinges	Self balancing with variable hinges
Rinse aid indicator	Light	Min. and max. frontal panel weight	2 - 8 kg
End of cycle indicator	ActiveLight	Min. and max plinth height	100 - 228 mm
Washing system	Planetarium	Adjustable feet	7cm, from 860 to 930 mm
Third spray arm	Single	Additional gaskets	Yes, with stainless steel plate
Water softener	With electronic setting	Back cover	Yes
Turbidity sensor Aquatest	Yes	Depth of dishwasher with open door (mm)	1146
Flood protection system	Total Acquastop	Back feet adjustable from front	Yes
Water supply	Single; cold/hot water max. 60°C - energysave with hot water up to 35%		

Electrical Connection

Plug	(I) Australia	Frequency (Hz)	50 Hz
Connected power	1800 W	Type of connection	Single-phase
Current	10 A	Power supply cable length	140 cm
Voltage	220-240 V		

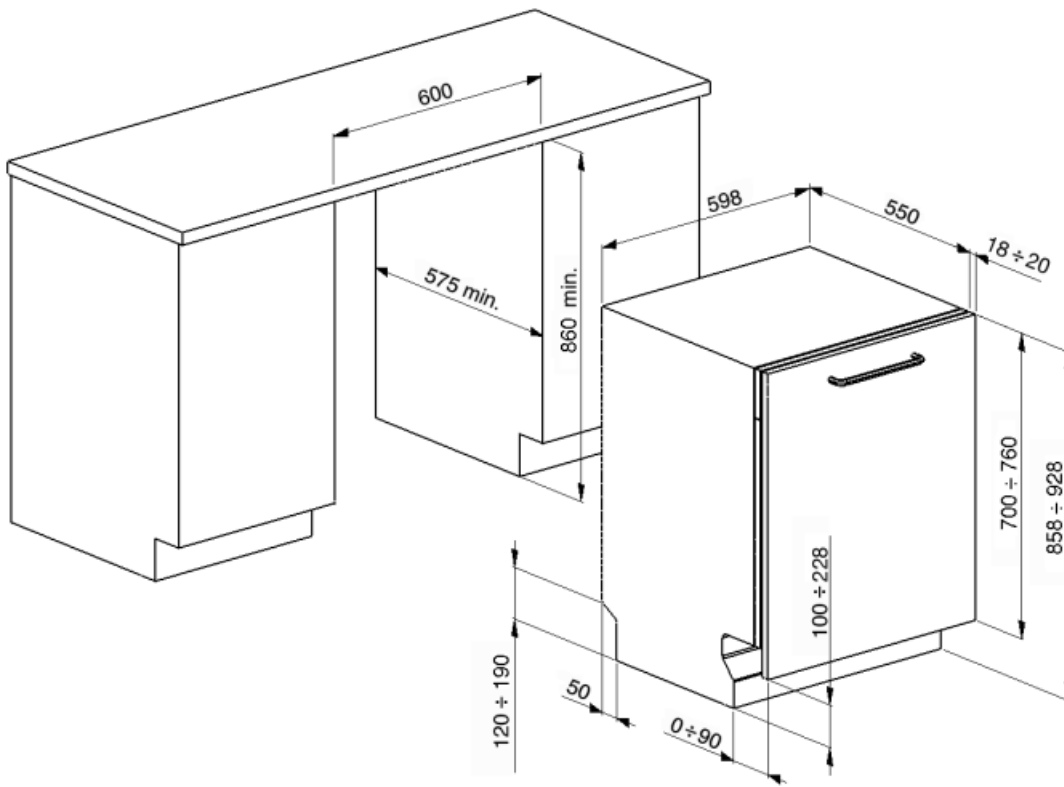

Not included accessories



KITPL60N

Toekick Kit in Black colour with adjustable height and deepness. Can be installed over all the fully integrated and underbench models with variable fulcrum or flexifit hinges.



KIT86VX

stainless steel panel with Victoria handle. Can be fitted on the fully integrated dishwashers H86 with no Flexifit hinges. It is not possible to install it on the models with stainless steel panel



KITPL60B

Toekick Kit in White colour with adjustable height and deepness. Can be installed over all the fully integrated and underbench models with variable fulcrum or flexifit hinges.

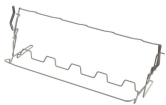

KITGH

Kit glass holder. It has to be fitted on the first basket but only if there are foldable racks

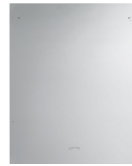

KIT86X

stainless steel panel with holes for Canali or Opera handle. Can be fitted on the fully integrated dishwashers H86 with no Flexifit hinges. It is not possible to install it on the models with stainless steel panel



KITPL60X























Toekick Kit in Stainless Steel with adjustable height and deepness. Can be fitted over all the fully integrated and underbench models with variable fulcrum or flexifit hinges.



KITPLV2

Kit extension for dishwasher and washing machine: lenght mt. 2

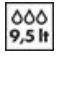
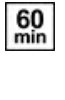
Symbols glossary (TT)

	<p>Activelight is an led light which projects a red spot onto the floor beneath the dishwasher when the appliance is in use.</p>		<p>Aquatest measures the clarity of the water during an auto program, and automatically ensures the minimum consumption of water and energy.</p>
	<p>Anti-drip: Some models of dishwashers are equipped with special polymer nozzles anti-drip, that improve the process of drying.</p>		<p>COMM_HEIGHT_86_72dpi</p>
	<p>Delay Timer: The delay timer can postpone the start of the program by up to 24 hours.</p>		<p>FlexiDuo: The FlexiDuo 3rd cutlery basket allows you to arrange cutlery or small cups, ladles, or bulky utensils however you like: it consists of two separate and moveable modules.</p>
	<p>Flexitabs: Flexitabs adjusts the wash cycle to give the best possible results regardless of the type of detergent used.</p>		<p>FlexiZone: The ½ load flexizone allows you to wash a reduced load saving energy, water and time and there are no restrictions on where the items are placed.</p>
	<p>The new ExtraGlide guide system, available on top of the range models, makes the second basket even smoother and softer. In fact, it facilitates the extraction of the introduction, even at full load and, for the greater excursion, the insertion of crockery is also facilitated in the rear part.</p>		<p>Inverter technology: The evolution of Smeg's driers towards more intelligent and environmentally sustainable models has led to the choice of using Inverter technology with heat pumps, which reduces significantly energy consumption.</p>
	<p>Noise Level: Excellent insulation and special devices keep noise to a minimum.</p>		<p>PLANETARIUM_WASHING_SYSTEM_72dpi</p>
	<p>Auto 45°- 65°: The auto programme regulates the length of a cycle depending on the need for a pre-wash and the number of rinses required.</p>		<p>Crystals: The Crystals programme is dedicated to delicate dishes such as glasses and china.</p>
	<p>Soak programme: The soak programme provides a rinse to prevent dirt from drying.</p>		<p>Rapid 27 Mins: The rapid 27 mins quick program takes just 27 minutes to wash a load.</p>
	<p>Ultraclean: The Ultraclean option performs a final rinse at a high temperature of 70°C eliminating virtually all bacteria.</p>		<p>REF_PRG_NORMAL_ECO_72dpi</p>
	<p>The symbols show the number of plate settings of the dishwasher.</p>		<p>Total Acquastop: In addition to the partial Acquastop protection present in all Smeg dishwashers, some models have an electronic device fitted to the water intake hose, which monitors water levels in the machine, detects leaks in the hose and switches off the water supply immediately when necessary.</p>
	<p>System WaterSave ensures the best washing results with minimal water consumption depending on the model of dishwasher.</p>		<p>...</p>
	<p>...</p>		<p>...</p>



...



...



The Dry Assist + option, in addition to saving energy, ensures perfect drying of the dishes by opening the door automatically at the end of the wash c