

DWAI6D15XT3



Product Family	Dishwashers
Commercial width	60 cm
Commercial height	86 cm
Installation	Partially-integrated built-in
Kitchen panel	Not supplied
N° baskets	3, FlexiDuo
Motor	Inverter
EAN code	8017709297152



Programs



N. of programmes	10	Auto sensor 45-65	Yes
Washing temperatures	38, 45, 50, 55, 65, 70, 75 °C	Quiet (~2 dB)	Yes
Soak	Yes	Intense	Yes
Express 27'	Yes	Sterilise	Yes
Crystal	Yes	Regular	Yes
Full express - 60 minutes	Si	Normal ECO	Yes

Options



Dry Assist+ option	Yes	Options for tabs FlexiTabs	Yes
Delay timer option	Up to 24 hours	Special programs option	Si
1/2 load FlexiZone option	Yes		

Baskets



Basket colour	Grey	Largest loadable dish in upper basket	19,0 cm
Basket components colour	Grey	Lower Basket	With completely foldable racks and glass holder

Handle	In plastic with stainless steel insert on upper and lower basket	Lower basket with anti-drip inserts	Yes
Upper Basket	With 3 foldable racks	Largest loadable dish in lower basket	35,0 cm
Height adjustment of the upper basket	On three levels	Colour Inner Components	Blue
Sliding Guides Extra Glide	Yes	Cutlery basket	13 place settings sliding

Technical Features



Width (mm)	598 mm	Drying system	Natural condenser drying, with Dry Assist + automatic door opening system at the end of the cycle
Depth (mm)	547 mm	Steam protection	In plastic
Display type	LED display	Internal light	With White led
Product Height (mm)	858 mm	Internal light	With White led
Controls	Electronic	Tub material	Stainless steel
Display	Delayed start, Programme time indicator, Time to end indication, Dynamics programme time indicator	Filter	Stainless steel
Programme graphics	Symbols	Concealed heating element	Yes
Rinse aid indicator	Light	Hinges	Self balancing with variable hinges
End of cycle indicator	On display, with acoustic signal	Min. and max plinth height	100 - 215 mm
Washing system	Planetarium	Adjustable feet	7cm, from 860 to 930 mm
Third spray arm	Single	Additional gaskets	Yes, with stainless steel plate
Turbidity sensor Aquatest	Yes	Back cover	Yes
Flood protection system	Total Acquastop	Depth of dishwasher with open door (mm)	1146
Water supply	Single; cold/hot water max. 60°C - energysave with hot water up to 35%	Back feet adjustable from front	Yes
Max water hardness	100°fH;58°dH	Removable top	

Electrical Connection

Plug	(I) Australia	Frequency (Hz)	50 Hz
Connected power	1800 W	Type of connection	Single-phase
Current	10 A	Power supply cable length	140 cm
Voltage	220-240 V		

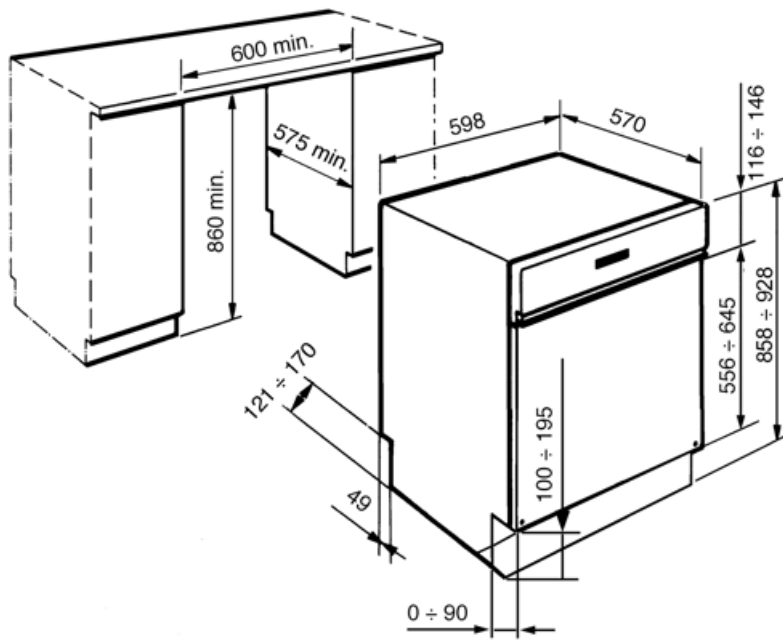

Compatible Accessories

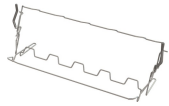

KITGH

Kit glass holder. It has to be fitted on the first basket but only if there are foldable racks



KITPL60N

Toekick Kit in Black colour with adjustable height and deepness. Can be installed over all the fully integrated and underbench models with variable fulcrum or flexifit hinges.



KITPLV2

Kit extension for dishwasher and washing machine: lenght mt. 2



KITPL60B























Toekick Kit in White colour with adjustable height and deepness. Can be installed over all the fully integrated and underbench models with variable fulcrum or flexifit hinges.



KITPL60X

Toekick Kit in Stainless Steel with adjustable height and deepness. Can be fitted over all the fully integrated and underbench models with variable fulcrum or flexifit hinges.

Symbols glossary

	<p>Aquatest measures the clarity of the water during an auto program, and automatically ensures the minimum consumption of water and energy.</p>		<p>Anti-drip: Some models of dishwashers are equipped with special polymer nozzles anti-drip, that improve the process of drying.</p>
	<p>COMM_HEIGHT_86_72dpi</p>		<p>Delay Timer: The delay timer can postpone the start of the program by up to 24 hours.</p>
	<p>The Dry Assist + option, in addition to saving energy, ensures perfect drying of the dishes by opening the door automatically at the end of the wash cycle.</p>		<p>Fingerprint proof stainless steel: Fingerprint proof stainless steel keeps stainless steel looking as good as new.</p>
	<p>FlexiDuo: The FlexiDuo 3rd cutlery basket allows you to arrange cutlery or small cups, ladles, or bulky utensils however you like: it consists of two separate and moveable modules.</p>		<p>Flexitabs: Flexitabs adjusts the wash cycle to give the best possible results regardless of the type of detergent used.</p>
	<p>FlexiZone: The 1/2 load flexizone allows you to wash a reduced load saving energy, water and time and there are no restrictions on where the items are placed.</p>		<p>The new ExtraGlide guide system, available on top of the range models, makes the second basket even smoother and softer. In fact, it facilitates the extraction of the introduction, even at full load and, for the greater excursion, the insertion of crockery is also facilitated in the rear part.</p>
	<p>Inverter technology: The evolution of Smeg's driers towards more intelligent and environmentally sustainable models has led to the choice of using Inverter technology with heat pumps, which reduces significantly energy consumption.</p>		<p>Noise Level: Excellent insulation and special devices keep noise to a minimum.</p>
	<p>PLANETARIUM_WASHING_SYSTEM_72dpi</p>		<p>Auto 45°- 65°: The auto programme regulates the length of a cycle depending on the need for a pre-wash and the number of rinses required.</p>
	<p>Crystals: The Crystals programme is dedicated to delicate dishes such as glasses and china.</p>		<p>Soak programme: The soak programme provides a rinse to prevent dirt from drying.</p>
	<p>Rapid 27 Mins: The rapid 27 mins quick program takes just 27 minutes to wash a load.</p>		<p>Ultraclean: The Ultraclean option performs a final rinse at a high temperature of 70°C eliminating virtually all bacteria.</p>
	<p>REF_PRG_NORMAL_ECO_72dpi</p>		<p>The symbols show the number of plate settings of the dishwasher.</p>
	<p>Total Acquastop: In addition to the partial Acquastop protection present in all Smeg dishwashers, some models have an electronic device fitted to the water intake hose, which monitors water levels in the machine, detects leaks in the hose and switches off the water supply immediately when necessary.</p>		<p>System WaterSave ensures the best washing results with minimal water consumption depending on the model of dishwasher.</p>



...



...



...



...



...

Benefit (TT)

FlexiDuo

The flexible third basket provides additional space, adapting to the load to accommodate various types of dishes, ensuring optimal organization and efficient use of interior capacity

The third FlexiDuo basket consists of two separate sections that can be handled independently of each other, stacked and/or removed, offering loading flexibility for every need. Depending on the arrangement, it allows cups, tall glasses, bulky utensils and pots and pans to be placed in the upper basket.

Planetarium Wash System

Full and deep wash coverage thanks to the advanced movement of the spray arm, an innovation patented by Smeg

Smeg's patented Planetarium Wash System guarantees impeccable cleaning. With a simultaneous double movement of the sprayer and 65 rotations per minute, it reaches every nook and cranny for extraordinary results. Dishes, glasses and utensils will be perfectly clean in no time. An intelligent system where efficiency and style meet, delivering brilliant results effortlessly.

Extra Glide Telescopic Guides

Smoother and more stable loading and unloading operations

Extra Glide telescopic guides ensure smooth and safe extraction of the upper basket, even with heavy loads. The telescopic design ensures smooth, stable and silent movement, improving ergonomics and convenience. Ideal for optimising space and ease of use, they combine durability and comfort in every washing operation.

DryAssist+

The Dry Assist+ system of automatic door opening at the end of the cycle ensures fast and energy-efficient drying