

DWAU6D15XT3



Product Family	Dishwashers
Commercial width	60 cm
Commercial height	86 cm
Installation	Under counter built-in
N° baskets	3, FlexiDuo
EAN code	8017709297190



Programs



N. of programmes	10	Auto sensor 45-65	Yes
Washing temperatures	38, 45, 50, 55, 65, 70, 75 °C	Quiet (~2 dB)	Yes
Soak	Yes	Intense	Yes
Express 27'	Yes	Sterilise	Yes
Crystal	Yes	Regular	Yes
Full express - 60 minutes	Yes	Normal ECO	Yes

Options



Dry Assist+ option	Yes	Options for tabs FlexiTabs	Yes
Delay timer option	Up to 24 hours	Special programs option	Yes
1/2 load FlexiZone option	Yes		

Baskets



Basket colour	Grey	Largest loadable dish in upper basket	19,0 cm
Basket components colour	Grey	Lower Basket	With completely foldable racks and glass holder

Handle	In plastic with stainless steel insert on upper and lower basket	Lower basket with anti-drip inserts	Yes
Upper Basket	With 3 foldable racks	Largest loadable dish in lower basket	35,0 cm
Height adjustment of the upper basket	On three levels	Colour Inner Components	Blue
Sliding Guides Extra Glide	Yes	Cutlery basket	13 place settings sliding

Technical Features



Width (mm)	598 mm	Drying system	Natural condenser drying, with Dry Assist + automatic door opening system at the end of the cycle
Depth (mm)	547 mm	Steam protection	In plastic
Display type	LED display	Internal light	With White led
Product Height (mm)	858 mm	Internal light	With White led
Controls	Electronic	Tub material	Stainless steel
Display	Delayed start, Programme time indicator, Time to end indication, Dynamics programme time indicator	Filter	Stainless steel
Programme graphics	Symbols	Concealed heating element	Yes
Rinse aid indicator	Light	Hinges	Self balancing with fixed hinges
End of cycle indicator	On display, with acoustic signal	Min. and max plinth height	100 - 170 mm
Auto switch-off	Yes	Adjustable feet	7cm, from 860 to 930 mm
Washing system	Planetarium	Additional gaskets	Yes, with stainless steel plate
Third spray arm	Single	Back cover	Yes
Turbidity sensor Aquatest	Yes	Depth of dishwasher with open door (mm)	1146 mm
Flood protection system	Total Acquastop	Back feet adjustable from front	Yes
Water supply	Single; cold/hot water max. 60°C - energysave with hot water up to 35%	Adjustable plinth	By height and depth
Max water hardness	100°fH;58°dH	Top cover	In plastic

Electrical Connection

Connected power	1800 W	Type of connection	Single-phase
Current	10 A	Power supply cable length	140 cm
Voltage	220-240 V	Plug	(I) Australia
Frequency (Hz)	50 Hz		

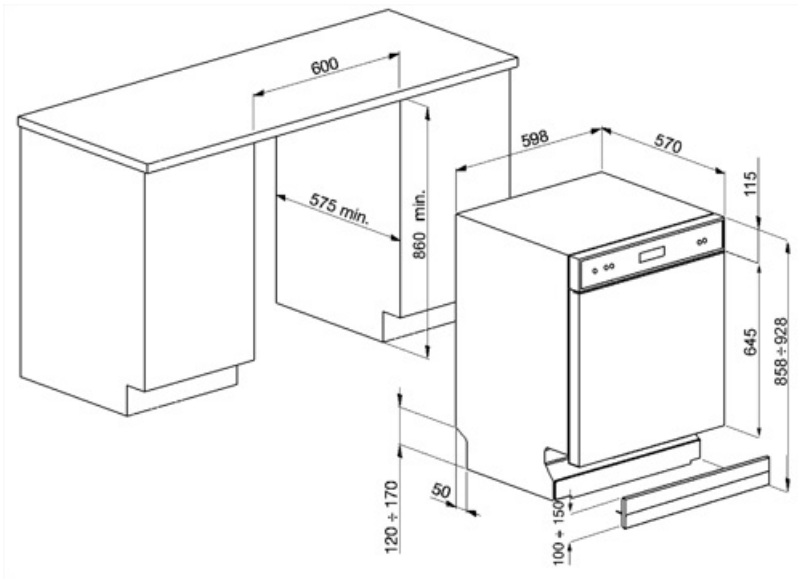

Compatible Accessories



KITGH

Kit glass holder. It has to be fitted on the first basket but only if there are foldable racks



KITPL60FABN

Toekick Kit in Black colour with adjustable height. Can be fitted over all the fully integrated and underbench models with Fixed Fulcrum. Can be installed also on the models with variable fulcrum or flexifit hinges.



KITPLV2

Kit extension for dishwasher and washing machine: lenght mt. 2



KITPL60FABB























Toekick Kit in White colour with adjustable height. Can be fitted over all the fully integrated and underbench models with Fixed Fulcrum. Can be installed also on the models with variable fulcrum or flexifit hinges.



KITPL60FABX

Toekick Kit in Stainless Steel with adjustable height. Can be fitted over all the fully integrated and underbench models with Fixed Fulcrum. Can be installed also on the models with variable fulcrum or flexifit hinges.

Symbols glossary

	Aquatest measures the clarity of the water during an auto program, and automatically ensures the minimum consumption of water and energy.		Anti-drip: Some models of dishwashers are equipped with special polymer nozzles anti-drip, that improve the process of drying.
	COMM_HEIGHT_86_72dpi		Delay Timer: The delay timer can postpone the start of the program by up to 24 hours.
	Fingerprint proof stainless steel: Fingerprint proof stainless steel keeps stainless steel looking as good as new.		FlexiDuo: The FlexiDuo 3rd cutlery basket allows you to arrange cutlery or small cups, ladles, or bulky utensils however you like: it consists of two separate and moveable modules.
	Flexitabs: Flexitabs adjusts the wash cycle to give the best possible results regardless of the type of detergent used.		FlexiZone: The ½ load flexizone allows you to wash a reduced load saving energy, water and time and there are no restrictions on where the items are placed.
	The new ExtraGlide guide system, available on top of the range models, makes the second basket even smoother and softer. In fact, it facilitates the extraction of the introduction, even at full load and, for the greater excursion, the insertion of crockery is also facilitated in the rear part.		Inverter technology: The evolution of Smeg's driers towards more intelligent and environmentally sustainable models has led to the choice of using Inverter technology with heat pumps, which reduces significantly energy consumption.
	Noise Level: Excellent insulation and special devices keep noise to a minimum.		PLANETARIUM_WASHING_SYSTEM_72dpi
	Auto 45°- 65°: The auto programme regulates the length of a cycle depending on the need for a pre-wash and the number of rinses required.		Crystals: The Crystals programme is dedicated to delicate dishes such as glasses and china.
	Soak programme: The soak programme provides a rinse to prevent dirt from drying.		Rapid 27 Mins: The rapid 27 mins quick program takes just 27 minutes to wash a load.
	Ultraclean: The Ultraclean option performs a final rinse at a high temperature of 70°C eliminating virtually all bacteria.		REF_PRG_NORMAL_ECO_72dpi
	The symbols show the number of plate settings of the dishwasher.		Total Acquastop: In addition to the partial Acquastop protection present in all Smeg dishwashers, some models have an electronic device fitted to the water intake hose, which monitors water levels in the machine, detects leaks in the hose and switches off the water supply immediately when necessary.
	System WaterSave ensures the best washing results with minimal water consumption depending on the model of dishwasher.		Quick wash cycle for normally soiled mixed loads such as dishes and pans, even with dried-on residues. Dishes are washed and dried in 60 minutes.



The Regular programme is for dishes with regular dirt, even with dried-on residues.



SILENT: Wash cycle suitable for normally soiled dishes, even with dried-on residues. Ensures maximum noise reduction and is therefore ideal if you wish to run it during the night.



Allows you to enable additional programs when selected together with any wash cycle.



STERYL 75°: Intensive wash cycle ideal for plates, pots, pans, cutting boards, feeding bottles.



The Dry Assist + option, in addition to saving energy, ensures perfect drying of the dishes by opening the door automatically at the end of the wash cycle.