

FA490URR

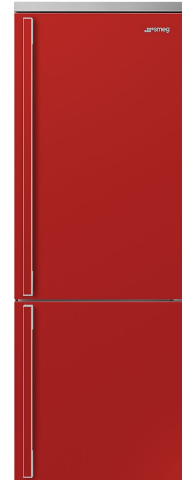

Product Family	Refrigerator
Installation	Free standing
Category	Bottom Mount
Cooling type	Total No Frost - Double Cooling system
Defrost	Automatic
Hinge type	Standard
Hinge position	Right
EAN code	8017709291358



Aesthetics



Aesthetic	Portofino	Side colour	Red
Colour	Red	Logo	Applied
Design	Flat	Door shelves profile color	Silver
Finishing	Glossy	Drawers profile color	Silver
Material	Metal sheet	Color of glass shelf profile	Silver
Handle colour	Rosso	Display	LED
Side material	Steel	Display position	Interno (cella frigo)

Refrigerator compartment features



No. of adjustable shelves	3	Type of crisper/vegetable drawers cover	Glass
Number of fruit and vegetables drawers	1	Life Plus zone-0°C	Yes
Shelves material	Glass	Internal light in fridge	Yes
Type of crisper/vegetable drawers cover	On sliding rails	Type of internal light (fridge)	LED
Crisper Cover	Yes		

Refrigerator Inner Door

No. of bottle shelves	1
-----------------------	---

Number of adjustable door shelves 3

Other Refrigerator features

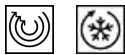

MultiFlow

Yes

Fan

Yes

Freezer compartment features

Number of drawers 3

No. of shelves 2

No. of compartments with flap 1

Type of shelves Glass

Other Freezer features



Ice maker

Manual

Fast freezing compartment

Yes

Other technical features



Functions display

Fast freezing button

Temperature alarm lamp

Door open alarm

Temperature Alarm

Type of temperature control

No. of compressors

Refrigerant gas type

Type of compressor

Refrigerant Quantity (gr)

Foam agent

Fast freezing, ECO, Temperature alarm

Yes

Yes

Acoustic and visual

Yes

Electronic

1

R600a

Inverter

1.5 oz

Cyclopentane

Performance / Energy Label - Reg. 2019

Airborne acoustical noise emissions 42 dB(A) re 1 pW

Climate class

SN, N, ST, T

Electrical Connection

Current 2,3 A

Voltage (V) 120 V

Frequency (Hz) 60 Hz

Power supply cable length 70 7/8 "

Plug (A) USA e Messico







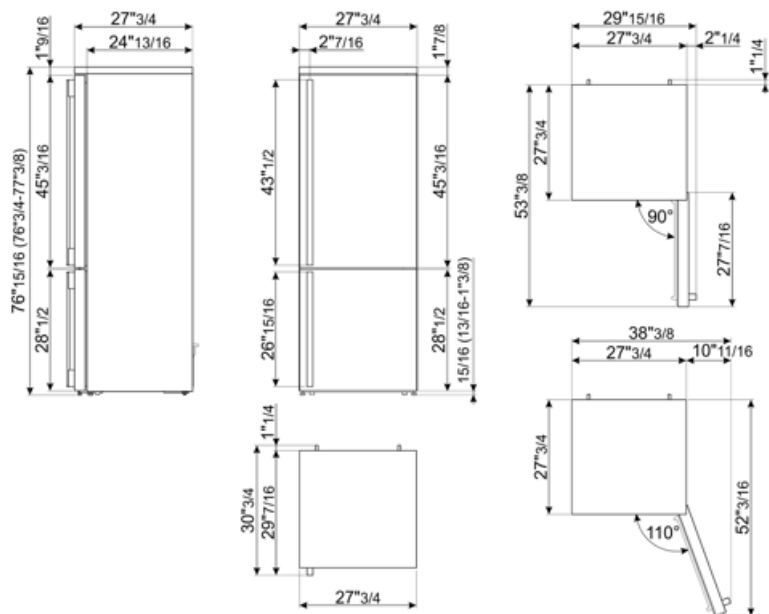



Logistic Information

Width 27 11/16 "
Depth without handle 27 11/16 "
Height 76 15/16 "

Product width with maximum doors opening 38 3/8 "
Product depth with handle 29 1/2 "
Product depth with doors open at 90° 53 3/8 "



Symbols glossary

	4 stars freezing compartment for better food preservation.		A++: Energy efficiency class A++ helps to save up to 20% energy compared to class A. Maximum performance with minimum consumption is guaranteed.
	The automatic defrost system works by automatically defrosting at regular intervals eliminating the need to defrost altogether.		LED display: to show programmes, functions and options selected and the time to the end of the cycle.
	Economical mode: Analyzes fridge functioning during the activation and optimizes the operating cycle in order to reduce power consumption.		Ventilated: Forced distribution of cold air in the refrigerator compartment, which allows even temperature distribution within the fridge.
	Fast freezing: The fast freezing function brings the temperature of the compartment down when activated a few hours prior to usage.		LED interior lighting: is a more energy efficient and long lasting way of illuminating the interior of the appliance.
	Life Plus 0°C: The temperature in the Lifeplus compartments is kept at 0°C, which preserves fresh meat and fish longer.		Smeg's evolution towards more intelligent and eco-friendly models has led to the choice of Inverter technology, which significantly reduces consumption.
	Air plus: keeps food fresher for longer.		