

FA63XBI



Product Family	Refrigerator
Installation	Free Standing
Category	Side-by-side
Sistema Total No - Frost	Total
Cooling type	Fan assisted refrigerator, no-frost freezer
Hinge type	Standard
EAN code	8017709199296



Aesthetics



Aesthetic	Classica	Logo colour	Stainless Steel
Colour	Stainless steel	Side material	Steel
Design	Flat	Side colour	White
Material	Stainless steel	Logotipo	Logotipo embutido
Door steel type	Normal	Display	LCD Touch
Handle kit to be ordered separately	No	Mostrar porções	
Handle	External	Dispenser	Ice & water
Handle type	Fixed	Water Filter	Yes
Handle colour	Stainless steel	HomeBar	No

Refrigerator compartment features



No. of adjustable shelves	3	Bottle shelf	No
Number of fruit and vegetables drawers	2	Type of crisper/vegetable drawers cover	Glass
Type of adjustable shelves	Glass	Life Plus zone-0°C	Yes
Type of crisper/vegetable drawers cover	On sliding rails	Internal light in fridge	Yes
Crisper Cover	Yes	Type of internal light (fridge)	LED

Refrigerator Inner Door

Number of adjustable door shelves	3	No. of bottle shelves	1
Adjustable door shelves with wire support	Yes	Bottle shelves with wire support	Yes

Other Refrigerator features



Accessories	Egg tray	Fan Ionizer	Yes
Natural Plus Blu Light	Yes		Yes
MultiFlow	Yes		

Freezer compartment features

Number of drawers	2	Type of internal light (freezer)	LED
No. of shelves	4	Type of shelves	Glass
Internal light in freezer	Yes		

Freezer Inner Door

No. of adjustable door shelves	2	Pizza box	No
---------------------------------------	---	------------------	----

Other Freezer features



Manual ice maker	No	Ice tray shelf	No
Fast freezing compartment	Yes		

Other technical features



Functions display	Holiday, Fast freezing, ECO, Control lock, Temperature alarm
MultiZone	No
Fast freezing button	Yes
Ligação à rede de água	
Temperature Alarm	Yes
Type of temperature control	Electronic
No. of compressors	1
Refrigerant gas type	R600a
Refrigerant Quantity (gr)	60 g
Espuma expansiva de isolamento	Ciclopentano

Etiqueta de Desempenho / Energia - Reg. 2019







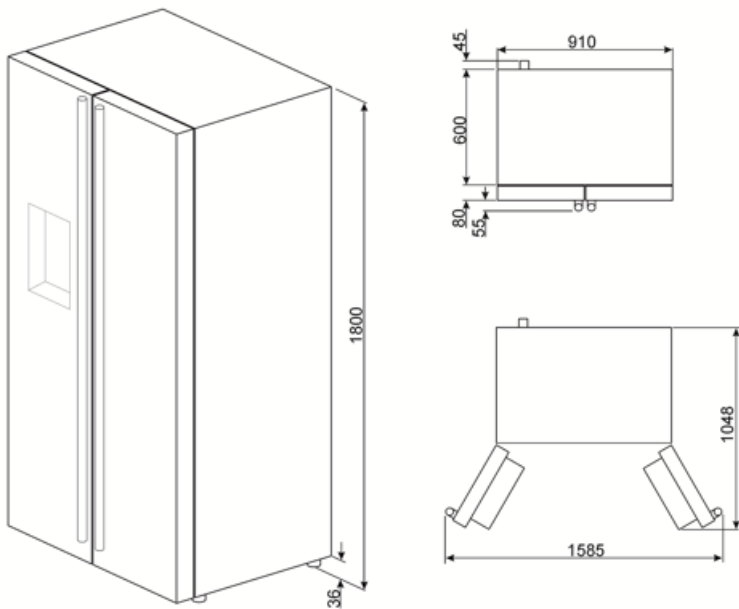







Airborne acoustical noise emissions	45 dB(A) re 1 pW	Classe climática	SN, N, ST, T
-------------------------------------	------------------	------------------	--------------

Electrical Connection

Plug	(F;E) Schuko	Voltage (V)	220-240 V
Electrical connection rating	150 W	Frequency (Hz)	50 Hz
Current	0,85 A	Power supply cable length	150 cm



Symbols glossary

	Compartimento de congelamento de 4 estrelas para uma melhor preservação dos alimentos.		Smeg Active Ion system improves the quality of the air inside the cell. Thanks to the generation of negatively charged ions released inside the fridge Active Ion system neutralizes unpleasant dust.
	Bloqueio para crianças: alguns modelos estão equipados com um dispositivo para bloquear o programa/ciclo para que não possa ser acidentalmente alterado.		A+: A classe de eficiência energética A+ ajuda a economizar até 10% de energia em comparação com a classe A. O desempenho máximo com consumo mínimo é garantido.
	Display LCD: para otimizar o desempenho e simplificar o uso do aparelho.		Modo económico: Analisa o funcionamento da geladeira durante a ativação e otimiza o ciclo de funcionamento, a fim de reduzir o consumo de energia.
	Ventilado: Distribuição forçada de ar frio no compartimento da geladeira, o que permite uma distribuição uniforme da temperatura dentro da geladeira.		CONGELAMENTO RÁPIDO: A função de congelamento rápido reduz a temperatura do compartimento quando ativado algumas horas antes do uso.
	Modo de economia de energia: O modo de economia de energia permite-lhe desativar a geladeira e manter o congelador a funcionar.		Iluminação interior LED: é uma forma mais eficiente em termos energéticos e duradoura de iluminar o interior do aparelho.
	Life Plus 0°C: A temperatura nos compartimentos Lifeplus é mantida a 0°C, o que preserva a carne fresca e o peixe por mais tempo.		Ar mais: mantém a comida mais fresca por mais tempo.
	Natural Plus Blu Light: Este exclusivo sistema Natural Plus Blu Light trabalha com a natureza para aumentar o tempo de armazenamento de frutas e legumes.		No Frost: Os sistemas sem geada e livre de geada impedem a formação de gelo, de modo que não é necessário descongelar.

Benefit (TT)

Natural Plus Blue Light

The Natural plus Blue light system extends the shelf life of fruit and vegetables while preserving their organoleptic properties

Plastic multiflow system

The Multiflow system ensures even distribution of cold air inside the refrigerator

Fan

The fan contributes to an even distribution of air inside the refrigerator

Refrigerant gas R600a

Environmentally friendly R600a refrigerant gas contributes to rapid cooling with lower energy consumption

Climate class

Climatic class SN-T makes the appliance suitable for working at room temperature between 10 °C and 43 °C (50 °F ~ 109 °F)

External handle

The external handle ensures practicality and ease of use of the refrigerator

Life Plus 0°

Temperature-controlled Life Plus compartment for optimal storage of specific food categories

Refrigerator Internal lighting

Interior lighting for perfect visibility of shelves in the refrigerator compartment

Freezer internal lighting

Interior lighting for perfect visibility of the drawers in the freezer compartment

Fruit and vegetable drawer

The fruit and vegetable drawer ensures the best storage conditions for fresh food, avoiding any contamination